



Mi • Light Subordinate New Brand

Smart LED Control System

Model No.: FUT043A / FUT044A / FUT045A

1. Introduction

Smart(set) LED strip control system is our newly developed high-end LED controller controlled by wireless remote controller, also with smart phone control and 4G long distance control(2.4GHz gateway is needed). The controller has auto-transmitting and auto-synchronizing function and with RGB,RGBW and RGB+CCT output mode.

This controller adopt the widely used 2.4GHz wireless technology with the features of low power consumption, long signal transmitting and strong anti-interference, etc. One compatible remote control many controllers at the same time. Widely used on the controlling of hotel lighting and home lighting.

2. Technical Data

Controller

Model No.: FUT043 / FUT044 / FUT045

Working Voltage: DC12V~24V

Output Max: 6A/Channel

Total Output Max: 15A

Working Temperature: -20~60°C

RF: 2.4GHz

Max Controlling Distance: 30m

Output Connection: Common anode

Size: 37*28*97mm

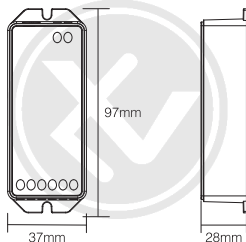

Remote control

Model No.: FUT088

Working Voltage: 3V(2*AAA Battery)

Transmitting Power: 6dBm

Standby Power: 20uA

Working Temperature: -20~60°C

Radio Frequency: 2400-2483.5MHz

Modulation Method: GFSK

Control Distance: 30m

Size: 47*16.5*134mm

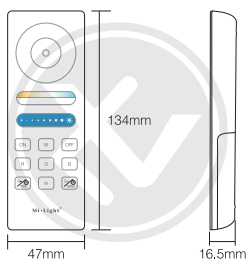

3. Products Key Diagram

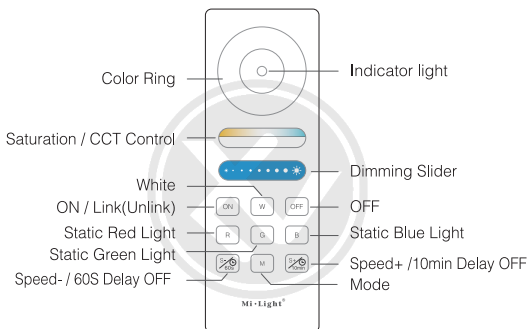

Touch the color ring to change colors.

 Under white light mode, adjust color temperature; Under color light mode, change color saturation.

 Slide the brightness slider to adjust the brightness.

 Touch ON button, turn on the linked device.

 Touch OFF button, turn off the linked device.

 Press the button to get white light.

 Static Red Light.

 Static Green Light.

 Static Blue Light.

 Dynamic mode switching button.

 Slow the speed under present dynamic mode.
Under static mode, Long press for 2 seconds, the light shine once, the light will be off after 60 seconds.

 Accelerate the speed under present dynamic mode.
Under static mode, Long press for 2 seconds, the light shine once, the light will be off after 10 minutes.

4. Auto-synchronization function

Different controllers can work synchronously when they are started at different times, controlled by the same remote, under same dynamic mode and with same speed.

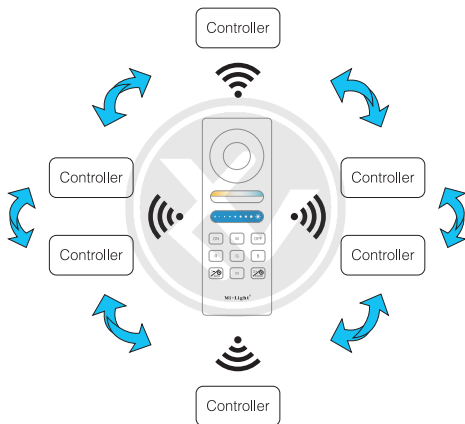

Auto-synchronization Diagram

Remark:

-  Indicating Auto-transmitting.
- Controller will be auto-synchronizing in the same dynamic modes and within 30m controlling distance.

5. Auto-transmitting function

One strip controller can transmit the signals from the remote control to another controller within 30m, as long as there is a strip controller within 30m, the remote control distance can be limitless.

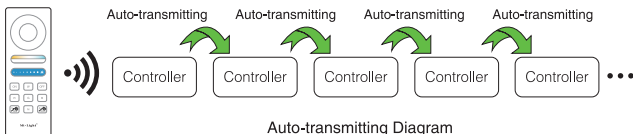

Auto-transmitting Diagram

6. Dynamic Mode Sheet

Number	Dynamic Mode	Brightness &Speed	Saturation	
1	Seven color gradual change	Adjustable	Adjustable	
2	White light Gradual change		Unadjustable	
3	RGB gradual change		Adjustable	Adjustable
4	Seven color jump to change			
5	Jump to change randomly			
6	Red light gradual change+Flash 3times			
7	Green light gradual change+Flash 3times			
8	Blue light gradual change+Flash 3times			
9	White light gradual change+Flash 3times		Unadjustable	

7. Linking&Unlinking

Remark: The light can be working after linking with the remote controller.

Linking Instructions

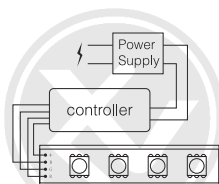

- 1 Switch off the light, after 10 seconds switch on again.



- 2 When the light on, short press " ON " **3 times** within 3 seconds.

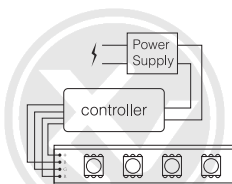

- 3 The light blink 3 times slowly means the linking is done successfully.



If the light not blink slowly, the linking failed, Pls switch off the light again, and follow the above steps again.

Unlinking Instructions

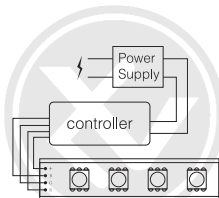

- 1 Switch off the light, after 10 seconds switch on again.



- 2 When the light on, short press " ON " **5 times** within 3 seconds.

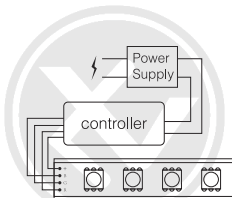

- 3 The light blinking 10 times quickly, means the unlinking successfully.



If the light not blink quickly, the unlink failed, pls switch off the light again, and follow the above steps to unlink again.

8. Controller connect to LED strip diagram

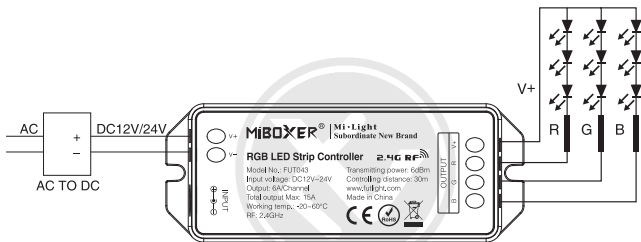

Controller connect to RGB LED strip diagram

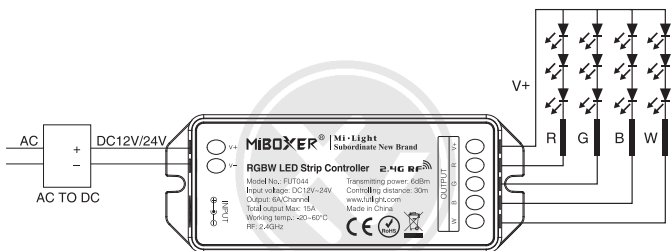

Controller connect to RGBW LED strip diagram

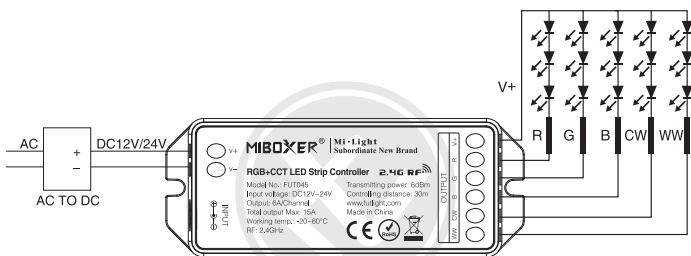

Controller connect to RGB+CCT LED strip diagram

9. Attention

1. Please check whether the input voltage of the constant voltage power supply is in accordance with the controller, and please check the connection of both the cathode and anode, otherwise the controller will be broken.
2. Please don't connect wires with power on. Please turn on again only when it is in right connection and no short circuit.
3. Please do not use the controller in the place with widely range metal area or strong electromagnetic wave nearby, otherwise, the remote distance will be seriously affected.