





2025

**OUTDOOR
LIGHTING
CATALOGUE**



OFERTA / OFFER / ANGEBOT / AJÁNLAT

<ul style="list-style-type: none"> Oświetlenie zewnętrzne LED LED outdoor lighting LED-Außenbeleuchtung LED kültéri világítás 	02-48	<ul style="list-style-type: none"> Latarka LED LED flashlight LED-Taschenlampe LED-es zseblámpa 	74-76
<ul style="list-style-type: none"> Girlanda LED LED Girland LED-Girlande LED füzér 	48-51	<ul style="list-style-type: none"> Lampa uliczna LED solarna LED solar street lamp LED-Solar-Straßenlampe LED napelemes utcai lámpa 	77-87
<ul style="list-style-type: none"> Naświetlacze LED LED floodlights LED-Flutlicht LED reflektorok 	52	<ul style="list-style-type: none"> Naświetlacz LED solarny LED solar floodlight LED-Solar-Flutlicht Solar LED reflektor 	88-91
<ul style="list-style-type: none"> Czujnik ruchu Motion sensor Bewegungssensor Mozgásérzékelő 	53	<ul style="list-style-type: none"> Lampa LED solarna LED solar lamp LED-Solarlampe Solar LED lámpa 	92-103
<ul style="list-style-type: none"> Naświetlacze LED LED floodlights LED-Flutlicht LED reflektorok 	54-64	<ul style="list-style-type: none"> Girlanda LED solarna LED solar garland Solar-LED-Girlande Solar LED füzér 	104-107
<ul style="list-style-type: none"> Złącze hermetyczne Hermetic triple connector Hermetischer Stecker Hermetikusan csatlakozó 	65	<ul style="list-style-type: none"> Lampa Robocza LED LED Work Lamp LED-Arbeitsleuchte LED munkalámpa 	109-116
<ul style="list-style-type: none"> Lampa Uliczna LED Street Lamp LED Straßenlaterne LED Utcai lámpa LED 	66-69	<ul style="list-style-type: none"> Lista produktów List of products Liste der Produkte A termékek listája 	109-113
<ul style="list-style-type: none"> Słup oświetleniowy Lighting pole Lichtmast Világítóoszlop 	70-73	<ul style="list-style-type: none"> Opakowania produktów Product packaging Produktverpackung Termékcsomagolás 	114-116

-  Lampa ogrodowa LED
-  LED garden lamp
-  LED Gartenlampe
-  LED kerti lámpa

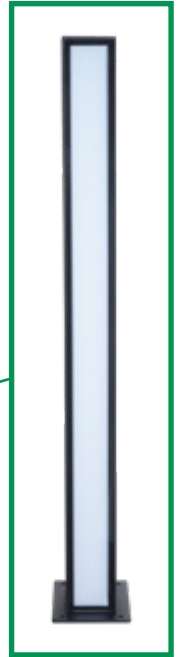
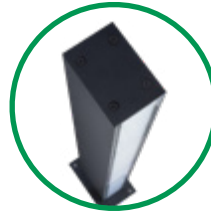

New 2025

New 2025



- 
- 
- 
- 
- 

6974

EAN code



5 903002 039892 >



- 
- 
- 
- 
- 

9298

EAN code



5 904703 019565 >



- 
- 
- 
- 
- 





9312

EAN code





5 904703 019572 >

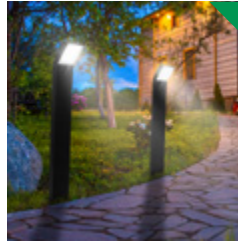

-  Oprawa architektoniczna LED
-  LED architectural luminaire
-  LED-Architekturleuchte
-  LED építészeti lámpatest



-  Lampa ogrodowa LED
-  LED garden lamp
-  LED Gartenlampe
-  LED kerti lámpa

EAN code 3460



5 908263 380363 >



230V AC
50/60Hz

 Motion Sensor

 230 x 165 x 100 mm

EAN code 3297



5 908263 380356 >



230V AC
50/60Hz

 230 x 165 x 100 mm

EAN code 3366



5 908263 380400 >



230V AC
50/60Hz

 Motion Sensor

 790 x 135 x 100 mm

EAN code 3321



5 908263 380387 >



230V AC
50/60Hz

 Motion Sensor

 490 x 135 x 100 mm

EAN code 3305



5 908263 380370 >



230V AC
50/60Hz

 490 x 135 x 100 mm

EAN code 3343





5 908263 380394 >



230V AC
50/60Hz

 790 x 135 x 100 mm

-  Aluminum
-  RAL 7021
-  4000K
-  550 lm
-  12W LED module
-  IP54

-  Lampa ogrodowa LED
-  LED garden lamp
-  LED Gartenlampe
-  LED kerti lámpa



New 2025



230V
AC
50/60Hz

80 x 80 x
800 mm

New 2025



230V
AC
50/60Hz

80 x 80 x
600 mm

New 2025



230V
AC
50/60Hz

80 x 80 x
500 mm

New 2025



230V
AC
50/60Hz

80 x 80 x
300 mm

EAN code **9306**



5 904703 019589 >

EAN code **9307**



5 904703 019596 >

EAN code **9308**



5 904703 019602 >

EAN code **9309**



5 904703 019619 >



*bulb not included

- Oświetlenie zewnętrzne LED
- LED outdoor lighting
- LED-Außenbeleuchtung
- LED kültéri világítás



230V
AC
50/60Hz

80 x 110 x
175 mm

New 2025

EAN code **9304**



5 904703 019640 >



230V
AC
50/60Hz

Motion
Sensor

80 x 128 x
175 mm

New 2025

EAN code **9305**



5 904703 019657 >



230V
AC
50/60Hz

SCHUKO

80 x 80 x
600 mm

New 2025

EAN code **9311**



5 904703 019664 >



230V
AC
50/60Hz

Motion
Sensor

80 x 80 x
600 mm

New 2025





EAN code **9310**



5 904703 019671 >

*bulb not included



-  Oświetlenie zewnętrzne LED
-  LED outdoor lighting
-  LED-Außenbeleuchtung
-  LED kültéri világítás



5046

EAN code



5 908263 380653 >



230V
AC
50/60Hz



5252

EAN code



5 908263 380691 >



230V
AC
50/60Hz



5295

EAN code



5 908263 380677 >



230V
AC
50/60Hz



5042

EAN code



5 908263 380646 >



230V
AC
50/60Hz



5085

EAN code



5 908263 380684 >



230V
AC
50/60Hz



5702

EAN code



5 908263 380660 >



230V
AC
50/60Hz



*bulb not included

- Oświetlenie zewnętrzne LED
- LED outdoor lighting
- LED-Außenbeleuchtung
- LED kültéri világítás



1325 EAN code

5 903002 036754 >



230V
AC
50/60Hz

155 x 210 x
380 mm

1644 EAN code

5 903002 036785 >



230V
AC
50/60Hz

175 x 155 x
780 mm

2546 EAN code

5 903002 036792 >



230V
AC
50/60Hz

175 x 155 x
1600 mm

1377 EAN code

5 903002 036761 >



230V
AC
50/60Hz

155 x 210 x
380 mm

1627 EAN code

5 903002 036778 >







230V
AC
50/60Hz

175 x 155 x
400 mm

*bulb not included



-  Oświetlenie zewnętrzne LED
-  LED outdoor lighting
-  LED-Außenbeleuchtung
-  LED kültéri világítás

8405 EAN code



5 904703 007227 >

8406 EAN code



5 904703 007234 >

8404 EAN code



5 904703 007210 >



230V
AC
50/60Hz

2290 x 147 x
170 mm



230V
AC
50/60Hz

2375 x 465 x
170 mm



230V
AC
50/60Hz

2375 x 465 x
450 mm



*bulb not included

HANA (anti-UV PC)



- Oprawa architektoniczna LED
- LED Outdoor wall light
- LED-Architektur-Leuchte
- LED építészeti lámpatest



230V
AC
50/60Hz

1773 EAN code



5 904703 002369 >



230V
AC
50/60Hz



230V
AC
50/60Hz



230V
AC
50/60Hz



8525 EAN code



5 904703 010210 >



Waterproof case



*bulb not included



(Aluminum) HANA

- Oprawa architektoniczna LED
- LED Outdoor wall light
- LED-Architektur-Leuchte
- LED építészeti lámpatest



230V
AC
50/60Hz



4153 EAN code



5 908263 383548 >



230V
AC
50/60Hz



6453 EAN code



5 908263 383555 >



230V
AC
50/60Hz



230V
AC
50/60Hz



230V
AC
50/60Hz



1254 EAN code



5 903002 037751 >



230V
AC
50/60Hz



1250 EAN code



5 903002 037720 >



230V
AC
50/60Hz



*bulb not included





(anti-UV PC) INEZ

- Oprawa architektoniczna LED
- LED Outdoor wall light
- LED-Architektur-Leuchte
- LED építészeti lámpatest

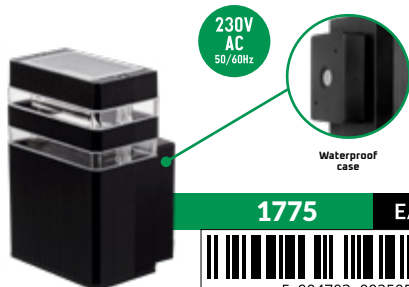

230V AC
50/60Hz

Waterproof case

1775 EAN code



5 904703 002505 >

1769 EAN code



5 904703 002512 >



230V AC
50/60Hz

8526 EAN code



5 904703 010227 >



230V AC
50/60Hz



1772 EAN code



5 904703 002499 >



230V AC
50/60Hz



RAL 7021



*bulb not included



INEZ (Aluminum)



- Oprawa architektoniczna LED
- LED Outdoor wall light
- LED-Architektur-Leuchte
- LED építészeti lámpatest



230V AC
50/60Hz



7356 EAN code



5 908263 386860 >

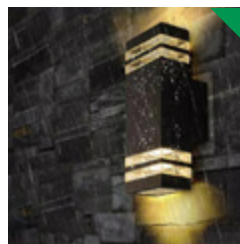

230V AC
50/60Hz



2833 EAN code



5 908263 383883 >



230V AC
50/60Hz



0652 EAN code



5 903002 033692 >



230V AC
50/60Hz



0653 EAN code



5 903002 033715 >



*bulb not included



MALIBU / MIAMI

GU10 E27

-  Lampa ogrodowa LED
-  LED garden lamp
-  LED Gartenlampe
-  LED kerti lámpa



230V
AC
50/60Hz

Ø108 x
610 mm

RAL
9005

1 x E27
(max 60 W)

IP54

3222

EAN code



230V
AC
50/60Hz

110 x 65 x
800 mm

3200

EAN code



230V
AC
50/60Hz

110 x 65 x
500 mm





3283

EAN code



*bulb not included



-  Lampa ogrodowa LED
-  LED garden lamp
-  LED Gartenlampe
-  LED kerti lámpa



230V
AC
50/60Hz

510 x 90 x
90 mm

1486

EAN code



230V
AC
50/60Hz

610 x 90 x
90 mm

2078

EAN code

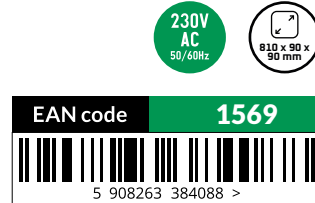

230V
AC
50/60Hz

810 x 90 x
90 mm

EAN code

1569



230V
AC
50/60Hz



610 x 90 x
90 mm

EAN code

7582



230V
AC
50/60Hz



610 x 90 x
90 mm

EAN code

7581



*bulb not included

- 🇵🇱 Oświetlenie zewnętrzne LED
- 🇬🇧 LED outdoor lighting
- 🇩🇪 LED-Außenbeleuchtung
- 🇭🇺 LED kültéri világítás



230V
AC
50/60Hz

95 x 75 x
238 mm

2 x GU10
(max 35 W)



EAN code 3213



5 903002 036624 >

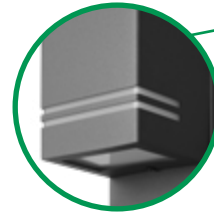

230V
AC
50/60Hz

100 x 112 x
490 mm

1 x GU10
(max 35 W)



EAN code 3235



5 903002 036631 >

*bulb not included



- 🇵🇱 Lampa ogrodowa LED
- 🇬🇧 LED garden lamp
- 🇩🇪 LED Gartenlampe
- 🇭🇺 LED kerti lámpa

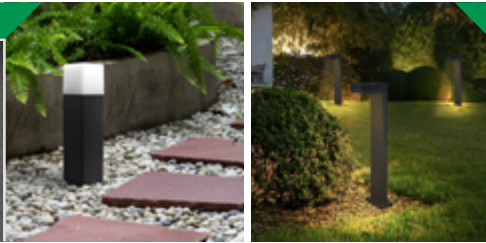

230V
AC
50/60Hz

80 x 80 x
325 mm



EAN code 1698



5 908263 380752 >

230V
AC
50/60Hz

140 x 185 x
600 mm

New 2025

EAN code 9299



5 904703 019558 >



*bulb not included



- Oprawa architektoniczna LED
- LED Outdoor wall light
- LED-Architektur-Leuchte
- LED építészeti lámpatest



230V AC 50/60Hz

Silver

1362 EAN code

5 903002 038208 >

230V AC 50/60Hz

RAL 9004

6439 EAN code

5 908263 383531 >



*bulb not included

MANILA

- Lampa ogrodowa LED
- LED garden lamp
- LED Gartenlampe
- LED kerti lámpa



0648 EAN code

5 903002 033838 >

RAL 9004

230V AC 50/60Hz

Silver

75 x 450 mm

1363 EAN code

5 903002 038192 >

0686 EAN code

5 903002 033845 >

RAL 9004

230V AC 50/60Hz

Silver

75 x 650 mm

1369 EAN code

5 903002 038215 >

230V AC 50/60Hz

RAL 9004

75 x 900 mm

0731 EAN code

5 903002 033821 >



*bulb not included

- Lampa ogrodowa LED
- LED garden lamp
- LED Gartenlampe
- LED kerti lámpa

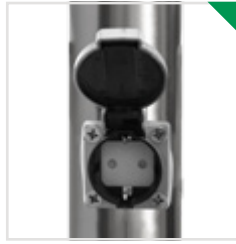

230V
AC
50/60Hz



6469

EAN code



5 908263 380578 >



230V
AC
50/60Hz



3393

EAN code



5 908263 380585 >

*bulb not included



- Lampa ogrodowa LED
- LED garden lamp
- LED Gartenlampe
- LED kerti lámpa



EAN code **3388**



5 908263 380561 >



230V
AC
50/60Hz



4364

EAN code



5 908263 380530 >

EAN code **4371**



5 908263 380547 >



230V
AC
50/60Hz



230V
AC
50/60Hz



5084

EAN code







5 908263 380554 >

230V
AC
50/60Hz



*bulb not included



-  Lampa ogrodowa LED
-  LED garden lamp
-  LED Gartenlampe
-  LED kerti lámpa







EAN code **7345**



5 908263 386907 >







EAN code **7346**



5 908263 386914 >







0622 EAN code



5 903002 033753 >







0623 EAN code



5 903002 033760 >







0645 EAN code



5 903002 033784 >







0657 EAN code



5 903002 033807 >



*bulb not included

- Lampa ogrodowa LED
- LED garden lamp
- LED Gartenlampe
- LED kerti lámpa



230V
AC
50/60Hz



4358

EAN code



5 908263 380516 >



230V
AC
50/60Hz



4352

EAN code



5 908263 380523 >

*bulb not included



- Lampa ogrodowa LED
- LED garden lamp
- LED Gartenlampe
- LED kerti lámpa

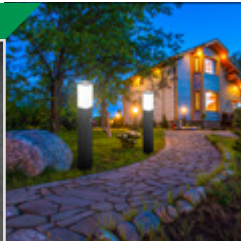

230V
AC
50/60Hz



4909

EAN code



5 908263 380493 >



230V
AC
50/60Hz



4714

EAN code



5 908263 380509 >

*bulb not included



KLOSZE HAVANA

-  Klosze do lamp
-  Lamp shades
-  Lampenschirme
-  Lámpabúra



EAN code **3824**



5 908263 384781 >

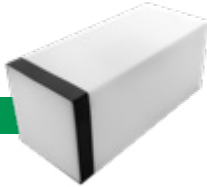

EAN code **3735**



5 908263 384774 >



EAN code **7497**



5 908263 387966 >



KLOSZE MANILA

-  Klosze do lamp
-  Lamp shades
-  Lampenschirme
-  Lámpabúra



EAN code **7104**



5 908263 385849 >

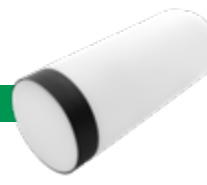

EAN code **7105**





5 908263 385856 >



SŁUPEK OGRODOWY ONTARIO 230V



-  Słupek ogrodowy 230V
-  Garden post 230V
-  Gartenpfosten 230V
-  Kerti oszlop 230V



7672 EAN code



5 904703 000150 >



7671 EAN code



5 904703 000143 >



- 
- 
- 

- 
- 
- 

- 
- 
- 

-  Lampa ogrodowa LED
-  LED garden lamp
-  LED Gartenlampe
-  LED kerti lámpa



RIO - RAL 9005

LED module 

-  Lampa ogrodowa LED
-  LED garden lamp
-  LED Gartenlampe
-  LED kerti lámpa



-  Lampa ogrodowa LED
-  LED garden lamp
-  LED Gartenlampe
-  LED kerti lámpa



Light adjustment: -120°/+120°

1648 EAN code



1647 EAN code



1643 EAN code



230V
AC
50/60Hz



230V
AC
50/60Hz



230V
AC
50/60Hz



-  Lampa ogrodowa LED
-  LED garden lamp
-  LED Gartenlampe
-  LED kerti lámpa



1642 EAN code



1641 EAN code



1638 EAN code



230V
AC
50/60Hz

500 x 120 x
120 mm



230V
AC
50/60Hz

600 x 120 x
120 mm



230V
AC
50/60Hz

800 x 120 x
120 mm

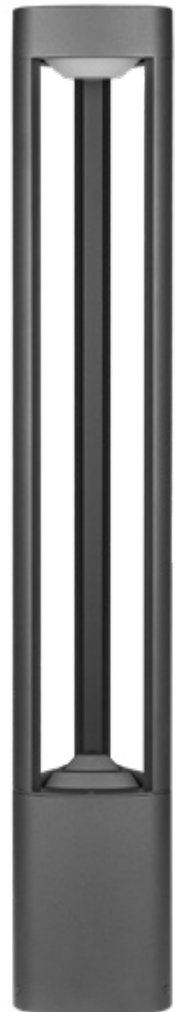

*bulb not included

- 🇵🇱 Oświetlenie zewnętrzne LED
- 🇬🇧 LED outdoor lighting
- 🇩🇪 LED-Außenbeleuchtung
- 🇭🇺 LED kültéri világítás



230V
AC
50/60Hz

600 x 108 x
108 mm

EAN code **1637**



New 2025

230V
AC
50/60Hz

800 x 108 x
108 mm

EAN code **9427**



*bulb not included



- 🇵🇱 Oświetlenie zewnętrzne LED
- 🇬🇧 LED outdoor lighting
- 🇩🇪 LED-Außenbeleuchtung
- 🇭🇺 LED kültéri világítás



230V
AC
50/60Hz

254 x 145 x
200 mm

EAN code **0554**



230V
AC
50/60Hz





600 x 145 x
145 mm

EAN code **0556**



*bulb not included



-  Lampa ogrodowa LED
-  LED garden lamp
-  LED Gartenlampe
-  LED kerti lámpa



Light distribution angle: 120°



230V
AC
50/60Hz

2500 x 140
x 140 mm

New 2025





EAN code **9313**



5 904703 019701 >



*bulb not included

-  Oprawa architektoniczna LED
-  LED Outdoor wall light
-  LED-Architektur-Leuchte
-  LED építészeti lámpatest



230V
AC
50/60Hz

115 x 30 x
85 mm

337 lm

ABS +
glass

New 2025

9303

EAN code



5 904703 019695 >



230V
AC
50/60Hz

600 x 76 x
42 mm

618 lm

PC
Aluminium

New 2025





EAN code

9300



5 904703 019688 >



-  Oprawa architektoniczna LED
-  LED Outdoor wall light
-  LED-Architektur-Leuchte
-  LED építészeti lámpatest



EAN code 0824



5 904703 002888 >

EAN code 0823



5 904703 002871 >

EAN code 8013



5 904703 002864 >

EAN code 0521



5 908263 389618 >

EAN code 0520







5 908263 389083 >

0455 EAN code



5 908263 389601 >



-  230V AC 50/60Hz
-  450 lm
-  300 x 30 x 40 mm
-  SMD 2835 9W



-  230V AC 50/60Hz
-  600 x 30 x 40 mm
-  950 lm
-  SMD 2835 19W







-  230V AC 50/60Hz
-  800 x 90 x 40 mm
-  1200 lm
-  SMD 2835 24W







-  230V AC 50/60Hz
-  1000 x 90 x 40 mm
-  1900 lm
-  SMD 2835 38W







-  230V AC 50/60Hz
-  1200 x 90 x 40 mm
-  2100 lm
-  SMD 2835 42W



-  230V AC 50/60Hz
-  1500 x 90 x 40 mm
-  2550 lm
-  SMD 2835 45W



-  Oprawa architektoniczna LED
-  LED Outdoor wall light
-  LED-Architektur-Leuchte
-  LED építészeti lámpatest



EAN code 1577



5 904703 008941 >



EAN code 1576



5 904703 008958 >



230V
AC
50/60Hz

2000 x 50
mm

2530 lm

SMD
2835 60W

RAL
9005

New 2025

EAN code 1565



5 904703 009009 >

EAN code 9122



5 904703 018131 >

230V
AC
50/60Hz

1500 x 50
mm

1900 lm

SMD
2835 45W

RAL
9005

1278 EAN code



5 904703 008996 >

230V
AC
50/60Hz

600 x 50
mm

900 lm

SMD
2835 19W

RAL
9005

230V
AC
50/60Hz

1000 x 50
mm

1350 lm

SMD
2835 30W

RAL
9005

230V
AC
50/60Hz

1000 x 50
mm

1350 lm

SMD
2835 30W

RAL
9003

Steel +
Acrylic

4000K

IP65

- 🇵🇱 Oprawa architektoniczna LED
- 🇬🇧 LED architectural luminaire
- 🇩🇪 LED Architekturleuchte
- 🇮🇹 LED építészeti lámpatest

Wymienna żarówka G9

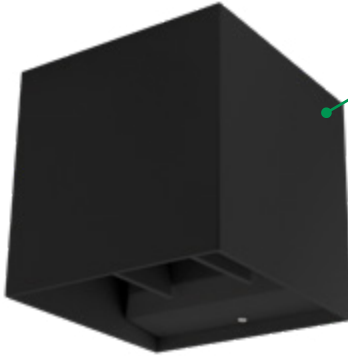

8014 EAN code

5 904703 002901 >

8015 EAN code

5 904703 002918 >

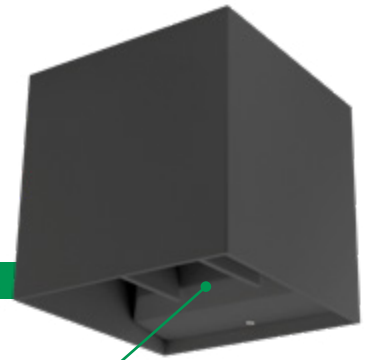

Wymienna żarówka G9



- 100 x 100 x 100 mm
- Aluminum
- RAL 9005
- 1 x LED G9 (max 9W)
- 0° - 120° Regulation
- IP44

*bulb not included

- 100 x 100 x 100 mm
- Aluminum
- RAL 7021
- 1 x LED G9 (max 9W)
- 0° - 120° Regulation
- IP44

KIRA

LED module

- 🇵🇱 Oprawa architektoniczna LED
- 🇬🇧 LED Outdoor wall light
- 🇩🇪 LED-Architektur-Leuchte
- 🇮🇹 LED építészeti lámpatest

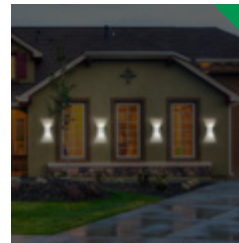

6895 EAN code

5 908263 384057 >

1458 EAN code

5 908263 383951 >



- 230V AC 50/60Hz
- RAL 9005



- 230V AC 50/60Hz
- RAL 7021



- 230V AC 50/60Hz
- RAL 9005

7167 EAN code

5 908263 385887 >



- 102 x 102 x 102 mm
- Aluminum+tempered glass
- 4000K
- 180 lm
- 2 x 3W XBD LED CREE
- 0° - 120° Regulation
- IP54

KIRA (PC + GLASS)



- Oprawa architektoniczna LED
- LED Outdoor wall light
- LED-Architektur-Leuchte
- LED építészeti lámpatest

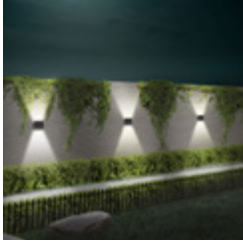

New 2025

EAN code **9291**

5 904703 019053 >



230V
AC
50/60Hz



*bulb not included



LED module

BELLA

- Oprawa architektoniczna LED
- LED Outdoor wall light
- LED-Architektur-Leuchte
- LED építészeti lámpatest



4470 EAN code

5 908263 385863 >

230V
AC
50/60Hz







230V
AC
50/60Hz

3052 EAN code

5 908263 385870 >



-  Oprawa architektoniczna LED
-  LED Outdoor wall light
-  LED-Architektur-Leuchte
-  LED építészeti lámpatest



230V AC
50/60Hz

170 x 90 x 80 mm

EAN code **3246**



5 903002 036600 >



230V AC
50/60Hz

245 x 120 x 80 mm

EAN code **2286**



5 903002 036273 >

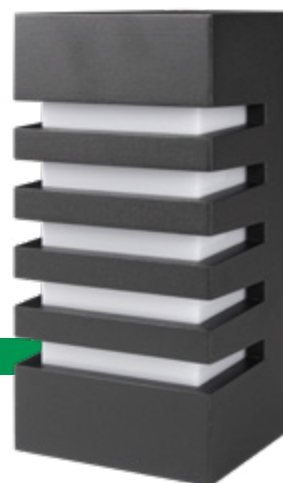





*bulb not included



LANGO

LED module 

-  Oprawa architektoniczna LED
-  LED Outdoor wall light
-  LED-Architektur-Leuchte
-  LED építészeti lámpatest

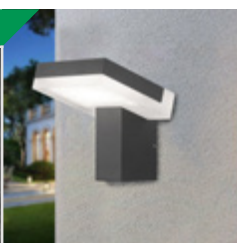

230V AC
50/60Hz

160 x 120 x 150 mm

EAN code **2392**



5 908263 385351 >



FRODA



- Oprawa architektoniczna LED
- LED Outdoor wall light
- LED-Architektur-Leuchte
- LED építészeti lámpatest



7324 EAN code



5 908263 386624 >



EAN code **3294**



5 908263 380431 >



*bulb not included



MIRIA

- Oprawa architektoniczna LED
- LED Outdoor wall light
- LED-Architektur-Leuchte
- LED építészeti lámpatest



EAN code **3205**







5 903002 036617 >



*bulb not included



-  Oprawa architektoniczna LED
-  LED architectural luminaire
-  LED Architekturleuchte
-  LED építészeti lámpatest

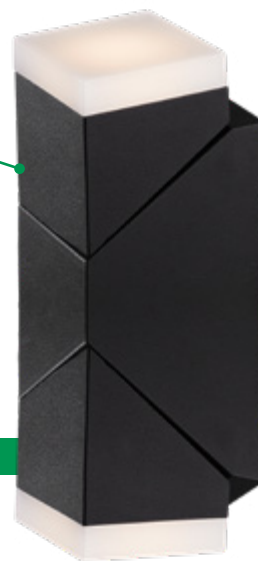

New 2025

230V
AC
50/60Hz

EAN code 9290



5 904703 019046 >

New 2025

230V
AC
50/60Hz

EAN code 9294







5 904703 019084 >



LORETO

LED module 

-  Oprawa architektoniczna LED
-  LED architectural luminaire
-  LED Architekturleuchte
-  LED építészeti lámpatest

230V
AC
50/60Hz

1288

EAN code



5 908263 383890 >

230V
AC
50/60Hz





1297

EAN code



5 908263 383906 >



-  Oprawa architektoniczna LED
-  LED Outdoor wall light
-  LED-Architektur-Leuchte
-  LED építészeti lámpatest



New 2025



EAN code **9414**



New 2025



EAN code **9151**



EAN code **2734**



New 2025



EAN code **9518**







New 2025



EAN code **9519**



-  Oprawa architektoniczna LED
-  LED Outdoor wall light
-  LED-Architektur-Leuchte
-  LED építészeti lámpatest



New 2025

230V
AC
50/60Hz



EAN code **9489**

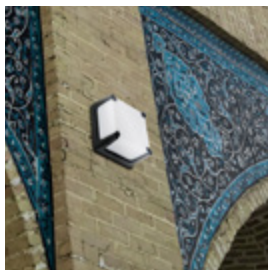

New 2025

230V
AC
50/60Hz



EAN code **9488**

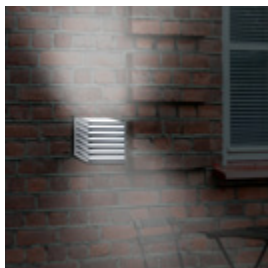

New 2025





230V
AC
50/60Hz



EAN code **9490**



*bulb not included

-  Oprawa architektoniczna LED
-  LED Outdoor wall light
-  LED-Architektur-Leuchte
-  LED építészeti lámpatest



230V
AC
50/60Hz

New 2025

9301 EAN code



5 904703 019626 >



230V
AC
50/60Hz



New 2025





9302 EAN code



5 904703 019633 >



New 2025

-  Oprawa architektoniczna LED
-  LED Outdoor wall light
-  LED-Architektur-Leuchte
-  LED építészeti lámpatest



9172 EAN code



5 904703 019411 >



EAN code **9006**



5 904703 017769 >







EAN code **9007**



5 904703 017776 >



*bulb not included

-  Oprawa architektoniczna LED
-  LED Outdoor wall light
-  LED-Architektur-Leuchte
-  LED építészeti lámpatest



230V
AC
50/60Hz



EAN code **0993**



5 903002 038239 >



230V
AC
50/60Hz



EAN code **0946**





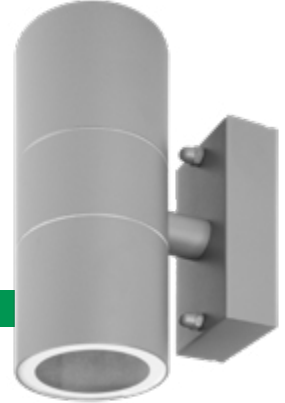

5 903002 038222 >



*bulb not included

LIDA (anti-UV PC)

-  Oprawa architektoniczna LED
-  LED Outdoor wall light
-  LED-Architektur-Leuchte
-  LED építészeti lámpatest



New 2025

230V
AC
50/60Hz



EAN code **9292**



5 904703 019060 >

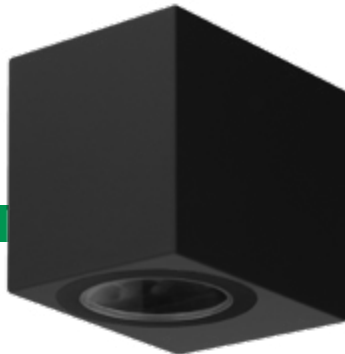

New 2025

230V
AC
50/60Hz



EAN code **9293**



5 904703 019077 >



*bulb not included

LIDA (Aluminum)



- Oprawa architektoniczna LED
- LED Outdoor wall light
- LED-Architektur-Leuchte
- LED építészeti lámpatest

230V
AC
50/60Hz



EAN code **1181**

5 903002 037843 >



230V
AC
50/60Hz



EAN code **1188**

5 903002 037867 >



230V
AC
50/60Hz



1180 EAN code

5 903002 037836 >



230V
AC
50/60Hz



1187 EAN code

5 903002 037850 >

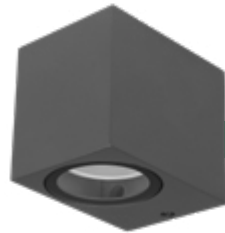

230V
AC
50/60Hz



EAN code **0516**

5 903002 034231 >



230V
AC
50/60Hz



EAN code **0208**

5 903002 034224 >



*bulb not included



RHINO

- Oprawa architektoniczna LED
- LED Outdoor wall light
- LED-Architektur-Leuchte
- LED építészeti lámpatest



230V
AC
50/60Hz



0942 EAN code

5 903002 037812 >



230V
AC
50/60Hz



0943 EAN code

5 903002 037829 >



*bulb not included



- Oprawa architektoniczna LED
- LED Outdoor wall light
- LED-Architektur-Leuchte
- LED építészeti lámpatest



EAN code 3336

5 903002 033227 >



230V AC 50/60Hz **RAL 7016**

3346 **EAN code**

5 903002 033234 >



EAN code 0280

5 903002 034248 >



EAN code 3389

5 903002 033203 >

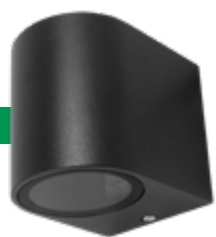

3391 **EAN code**

5 903002 033210 >



EAN code 2389

5 903002 034255 >

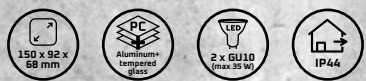

*bulb not included



RHINO / LIDA

- Oprawa architektoniczna LED
- LED Outdoor wall light
- LED-Architektur-Leuchte
- LED építészeti lámpatest

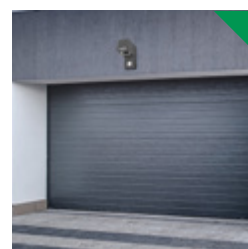

- Oprawa architektoniczna LED
- LED Outdoor wall light
- LED-Architektur-Leuchte
- LED építészeti lámpatest



5652 **EAN code**

5 908263 380806 >



5043 **EAN code**

5 908263 380790 >



*bulb not included



DORIS



- Oprawa architektoniczna LED
- LED Outdoor wall light
- LED-Architektur-Leuchte
- LED építészeti lámpatest



EAN code **0456**

5 903002 033746 >

7057 EAN code

5 908263 385719 >



230V AC
50/60Hz

RAL 9005



230V AC
50/60Hz

Steel

*bulb not included



CORSO / TOLA

- Oprawa architektoniczna LED
- LED Outdoor wall light
- LED-Architektur-Leuchte
- LED építészeti lámpatest



- Oprawa architektoniczna LED
- LED Outdoor wall light
- LED-Architektur-Leuchte
- LED építészeti lámpatest

6054 EAN code

5 903002 034880 >



230V AC
50/60Hz

EAN code **3535**

5 903002 036747 >







230V AC
50/60Hz



*bulb not included



-  Oprawa architektoniczna LED
-  LED Outdoor wall light
-  LED-Architektur-Leuchte
-  LED építészeti lámpatest



-  230V AC 50/60Hz
-  Motion Sensor
-  RAL 9005

EAN code **8475**







5 904703 008828 >







-  295 x 215 x 90 mm
-  PC
-  Stainless steel
-  1 x E27 (max 60 W)
-  IP44

*bulb not included

VIKI / KALIO

-  Oprawa architektoniczna LED
-  LED Outdoor wall light
-  LED-Architektur-Leuchte
-  LED építészeti lámpatest



-  Oprawa architektoniczna LED
-  LED Outdoor wall light
-  LED-Architektur-Leuchte
-  LED építészeti lámpatest



EAN code **7349**



5 908263 386990 >



EAN code **7350**



5 908263 386983 >





-  345 x 120 x 115 mm
-  Aluminum
-  RAL 9005
-  1 x E27 (max 60 W)
-  IP54

*bulb not included

-  250 x 180 x 95 mm
-  Aluminum + glass
-  RAL 9005
-  1 x E27 (max 60 W)
-  IP54

SANTIAGO

LED module 

-  Oprawa architektoniczna LED
-  LED Outdoor wall light
-  LED-Architektur-Leuchte
-  LED építészeti lámpatest



4120 EAN code





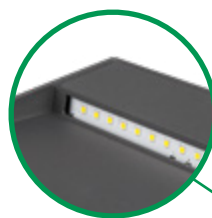

4118 EAN code



LED module 





TINO

-  Oprawa architektoniczna LED
-  LED Outdoor wall light
-  LED-Architektur-Leuchte
-  LED építészeti lámpatest







6458 EAN code



-  Oprawa architektoniczna LED
-  LED Outdoor wall light
-  LED-Architektur-Leuchte
-  LED építészeti lámpatest



-  Oprawa architektoniczna LED
-  LED Outdoor wall light
-  LED-Architektur-Leuchte
-  LED építészeti lámpatest



2879 EAN code



5 903002 036730 >



0544 EAN code



5 904703 009832 >







*bulb not included



PAULA



-  Oprawa architektoniczna LED
-  LED Outdoor wall light
-  LED-Architektur-Leuchte
-  LED építészeti lámpatest

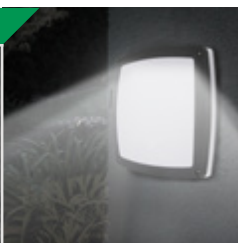

3254 EAN code



5 903002 036648 >



3269 EAN code



5 903002 036655 >



*bulb not included



REFLEKTORY GU10 / MARINIIO



- Lampa LED ogrodowa
- LED Garden Lamp
- LED-Gartenlampe
- LED kerti lámpa



230V AC
50/60Hz



EAN code **0654**



5 903002 033708 >



230V AC
50/60Hz



EAN code **7119**



5 908263 383500 >

*bulb not included



LED module

SERGIO

- Lampa LED ogrodowa
- LED Garden Lamp
- LED-Gartenlampe
- LED kerti lámpa



230V AC
50/60Hz



EAN code **2930**



5 904703 006244 >



230V AC
50/60Hz



EAN code **5594**



5 904703 006251 >



-  Lampa LED ogrodowa
-  LED Garden Lamp
-  LED-Gartenlampe
-  LED kerti lámpa



FUTC04M EAN code







230V
AC
50/60Hz

RGB
+
CCT

Ø272 x
75 mm



-  Oświetlenie zewnętrzne LED
-  LED outdoor lighting
-  LED-Außenbeleuchtung
-  LED kültéri világítás



MLTT03 EAN code







230V
AC
50/60Hz

RGB
+
CCT

227 x 167 x
40 mm



WALL WASHER LED

-  Oświetlenie zewnętrzne LED
-  LED outdoor lighting
-  LED-Außenbeleuchtung
-  LED kültéri világítás

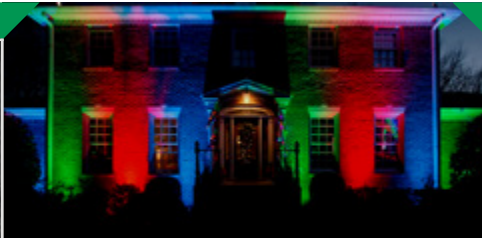

230V
AC
50/60Hz

RGB
+
CCT

521 x 64 x
62 mm

1600 lm

EAN code **RL3-24**



230V
AC
50/60Hz

RGB
+
CCT

1800 lm





1017 x 64 x
62 mm

EAN code **RL1-24**







KULE OGRODOWE

LED module   E27

-  Lampa LED ogrodowa kula
-  LED garden ball lamp
-  LED-Gartenkugellampe
-  LED kerti golyós lámpa



-  Lampa LED ogrodowa kula
-  LED garden ball lamp
-  LED-Gartenkugellampe
-  LED kerti golyós lámpa

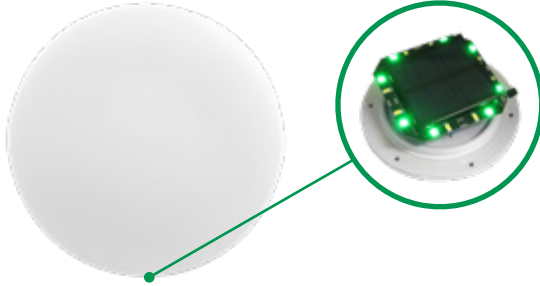





*bulb not included



 E27





KULE OGRODOWE E27

-  Lampa LED ogrodowa kula
-  LED garden ball lamp
-  LED-Gartenkugellampe
-  LED kerti golyós lámpa



*bulb not included



-  Lampa LED ogrodowa Donica
-  LED garden lamp Pot
-  LED-Gartenlampe Topf
-  LED kerti lámpa Pot



EAN code 1108



5 903002 039670 >

230V
AC
50/60Hz

Ø380 x
460 mm

RGB



EAN code 1109



5 908263 383432 >

230V
AC
50/60Hz

300 x 300 x
500 mm

RGB



EAN code 1260







5 903002 036570 >

230V
AC
50/60Hz

400 x 400 x
750 mm

RGB



-  Oprawa najazdowa LED
-  LED Ground light
-  LED Bodenleuchte
-  LED meghajtó lámpatest





230V AC
50/60Hz

 $\varnothing 110 \times 110 \text{ mm}$



3253 EAN code



5 903002 033180 >

3220 EAN code



5 903002 033173 >



230V AC
50/60Hz

 $110 \times 110 \times 110 \text{ mm}$



*bulb not included





230V AC
50/60Hz

 $\varnothing 108 \times 135 \text{ mm}$



3993 EAN code



5 903002 035443 >



1466 EAN code



5 903002 035436 >



230V AC
50/60Hz

 $108 \times 108 \times 135 \text{ mm}$



*bulb not included



-  Girlanda LED
-  LED Girland
-  LED-Girlande
-  LED füzér



Cable type: H05RN-F 2 x 1 mm

230V
AC
50/60Hz



Overall length:
10 m

1321

EAN code



5 904703 001218 >

230V
AC
50/60Hz



Overall length:
20 m

0457

EAN code



5 904703 001232 >

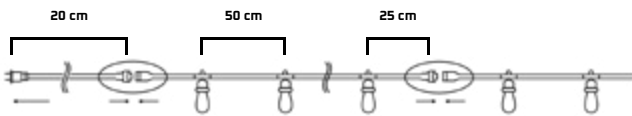

Cable type: H05RN-F 2 x 1 mm

230V
AC
50/60Hz



Overall length:
10 m

2817

EAN code



5 904703 001201 >

230V
AC
50/60Hz



Overall length:
15 m

7814

EAN code



5 904703 001287 >

230V
AC
50/60Hz



Overall length:
20 m

2544

EAN code



5 904703 001225 >

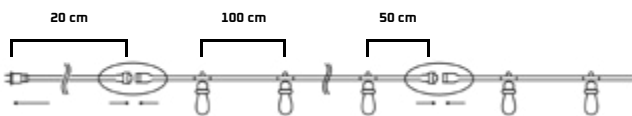

Permissible length in series: max. 200 m or max. 700W



*bulb not included

- Girlanda LED
- LED Girland
- LED-Girlande
- LED füzér



Cable type: PVC cable: H05VV-F 2 x 1 mm

230V AC 50/60Hz

10 x E27 ST14

Overall length: 10 m

0019 EAN code

5 904703 015000 >

230V AC 50/60Hz

5 x E27 ST14

Overall length: 5 m

0018 EAN code

5 904703 015017 >

230V AC 50/60Hz

20 x E27 ST14

Overall length: 20 m

0020 EAN code

5 904703 014997 >

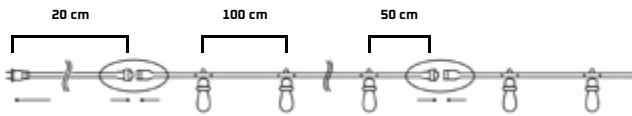
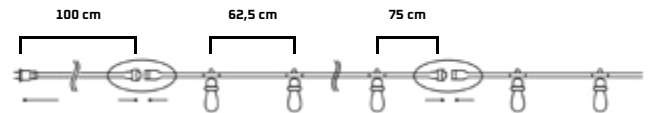





*bulb not included

Black

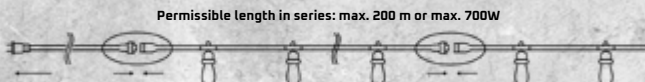
can be combined

IP44



-  Žarówka LED E27
-  LED bulb E27
-  E27 LED-Glühbirne
-  E27 LED izzó



1322 EAN code



5 904703 001256 >

0451 EAN code



5 904703 001249 >

1459 EAN code



5 904703 001263 >



- Girlanda LED 24V DC
- LED Girland 24V DC
- LED-Girlande 24V DC
- LED füzér 24V DC

Cable type: PVC cable: H03VV-F 2 X 0.5 mm

24V
DC



0016 EAN code

5 904703 014980 >

24V
DC



0017 EAN code

5 904703 015024 >

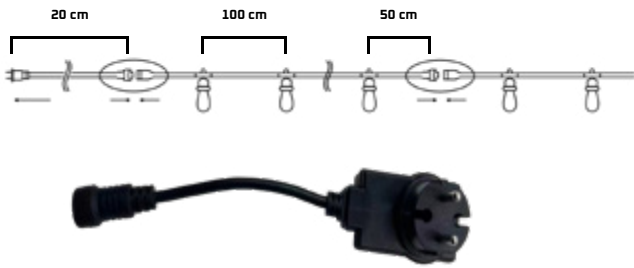

*bulb not included



24V E27

ŻARÓWKA LED





- Żarówka LED E27
- LED bulb E27
- E27 LED-Glühbirne
- E27 LED izzó





8637 EAN code

5 904703 014065 >

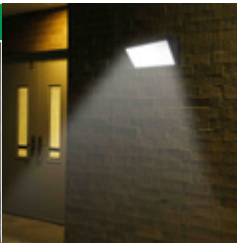

-  Oprawa architektoniczna LED
-  LED Outdoor wall light
-  LED-Architektur-Leuchte
-  LED építészeti lámpatest

230V
AC
50/60Hz

Index	Source of light	Power	Brightness	Colour Temperature	Dimensions [mm]	IP	Material	EAN code
5251	66 x SMD LED 2835	12W	1400LM	4000K	265 x 99 x 98	65	ABS + PC	 5 908263 385436 >





NAŚWIETLACZE LED MELIO

-  Naświetlacze LED
-  LED floodlights
-  LED-Flutlicht
-  LED reflektorok

230V
AC
50/60Hz

Index	Source of light	Power	Brightness	Colour Temperature	Dimensions [mm]	IP	Material	EAN code
6695	84 x SMD 2835	30W	2200LM	4000K	225 x 199 x 187	65	PC	 5 904703 006046 >

CZUJNIKI RUCHU

-  Czujnik ruchu
-  Motion sensor
-  Bewegungssensor
-  Mozgásérzékelő

230V
AC
50/60Hz



EAN code 1508



5 903002 036518 >



230V
AC
50/60Hz



EAN code 4992



5 903002 030233 >



230V
AC
50/60Hz



EAN code 4991



5 903002 030226 >

230V
AC
50/60Hz



EAN code 1375



5 903002 036495 >



230V
AC
50/60Hz



EAN code 1387



5 903002 036501 >



Index	Detection distance	Detection range	Max. Load	Type sensor	Adjustment angle (horizontal):	Adjustment angle (vertical):	IP	Dimensions [mm]
1508	Max. 12 m	180°	1200W	PIR	-20° - +20°	20°	44	65 x 85 x 92
4992					-	-90° - +100°		86 x 98 x 78
4991					-	-90° - +100°		86 x 98 x 78
1375					-90° - +90°	-90° - +90°		147 x 59 x 87
1387					-90° - +90°	-90° - +90°		147 x 59 x 87

-  Projektor LED
-  LED Projector
-  LED-Projektor
-  Projektor LED



EAN code **8072**





5 904703 005544 >

Index	Source of light	Power	Brightness	Colour Temperature	Dimensions [mm]	IP	Material
8072	216 x LUMILED 2835 SMD	100W	12000LM	4000K	280 x 254 x 80	65	Aluminum + tempered glass

PROJEKTOR LED PX

-  Projektor LED
-  LED Projector
-  LED-Projektor
-  Projektor LED



Index	Source of light	Power	Brightness	Colour Temperature	Dimensions [mm]	IP	Material	EAN code
3742	168 x PHILIPS 3030 SMD	150W	18000LM	5000-5500K	430,25 x 330 x 53,5	IP65 IK08	Aluminum + tempered glass	 5 903002 034989 >
3745	240 x PHILIPS 3030 SMD	200W	24000LM		470,25 x 360 x 53,5			 5 903002 034996 >

NAŚWIETLACZ LED ULTRON

LED module 

-  Naświetlacze LED
-  LED floodlights
-  LED-Flutlicht
-  LED reflektorok



4837

230V
AC
50/60Hz



1646

230V
AC
50/60Hz



1865

230V
AC
50/60Hz



5128

230V
AC
50/60Hz



5105















230V
AC
50/60Hz



5104

230V
AC
50/60Hz



Index	 Source of light	 Power	 Brightness	 Colour Temperature	 Dimensions [mm]	 Motion Sensor	 IP	 Material	EAN code
4837	SMD LED	20W	1600LM	4500K	114 x 90 x 28	No	65	Aluminum + PC milky	 5 904703 006930 >
1646		30W	2400LM		143 x 120 x 28,5				 5 904703 006909 >
1865		50W	4000LM		178 x 145,5 x 28,5				 5 904703 006916 >
5128		20W	1600LM		114 x 90 x 28	Yes			 5 904703 006961 >
5105		30W	2400LM		143 x 120 x 28,5				 5 903002 033685 >
5104		50W	4000LM		178 x 145,5 x 28,5				 5 903002 030646 >

-  Naświetlacze LED
-  LED floodlights
-  LED-Flutlicht
-  LED reflektorok



230V
AC
50/60Hz

Integrated
LED
module



Index	Source of light	Power	Brightness	Colour Temperature	Dimensions [mm]	Cable length [mm]	IP	Material	EAN code
1456	12 x SMD 2835	10W	800LM	4500K	72 x 66 x 22	150	65	Aluminum + tempered glass	 5 908263 384590 >
1447	24 x SMD 2835	20W	1600LM		102 x 86 x 26				 5 908263 384606 >
1463	36 x SMD 2835	30W	2400LM	6500K	116 x 102 x 26	300			 5 908263 384613 >
1792									 5 904703 005254 >
7818	60 x SMD 2835	50W	4000LM	4500K	160 x 134 x 26				 5 904703 001485 >
1795				6500K					 5 904703 005261 >
0939	120 x SMD 2835	100W	8000LM	4500K	225 x 192 x 28				 5 908263 384637 >
8683				6500K					 5 904703 015413 >
8681	SMD 2835	150W	12000LM	4500K	282 x 242 x 28				 5 904703 015390 >
8682		200W	16000LM		310 x 280 x 28				 5 904703 015406 >

NAŚWIETLACZE LED TIGA PIR

LED module 





-  Naświetlacze LED
-  LED floodlights
-  LED-Flutlicht
-  LED reflektorok





230V
AC
50/60Hz

Motion
Sensor









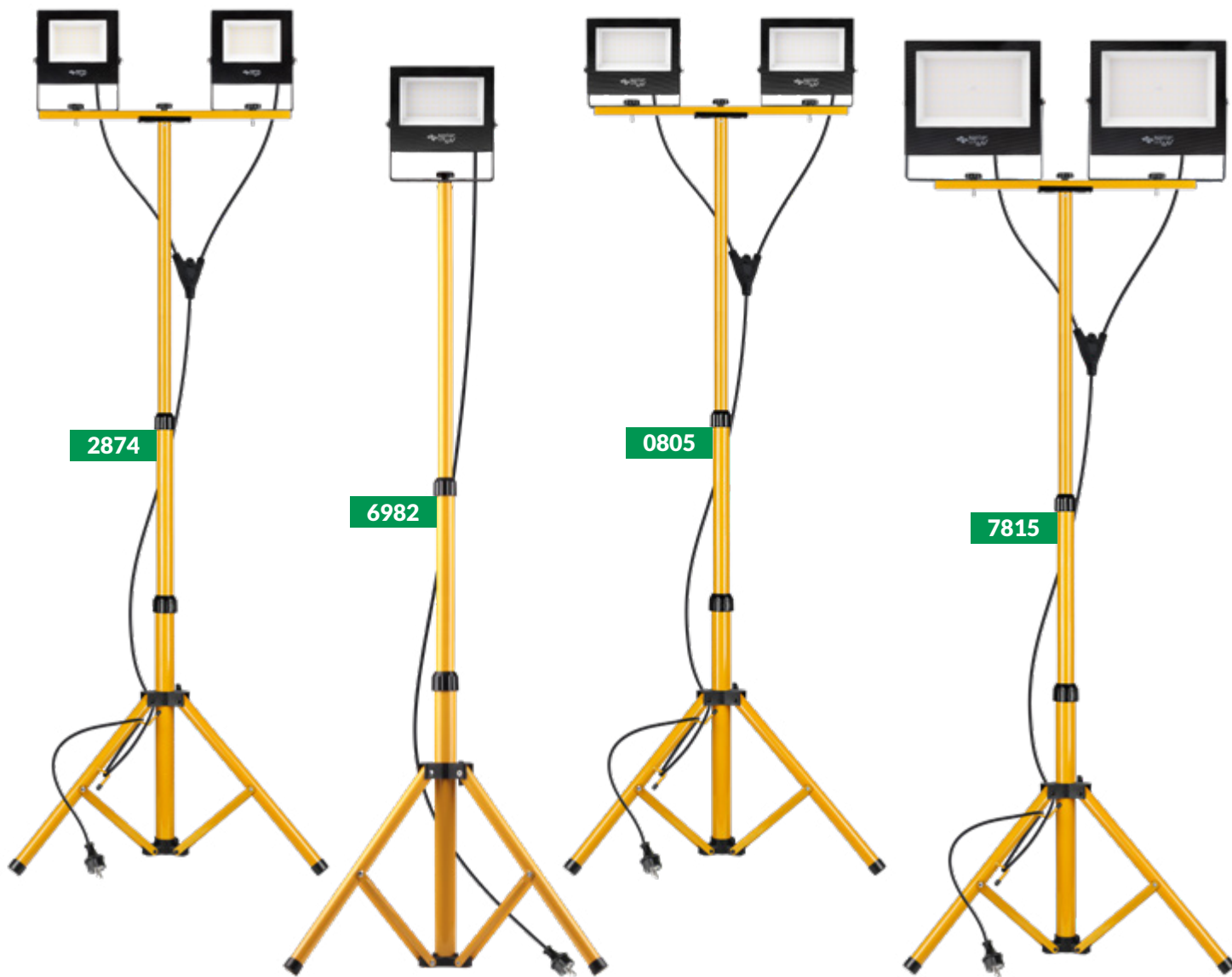

Integrated
LED
module



Index	Source of light	Power	Brightness	Colour Temperature	Dimensions [mm]	Cable length [mm]	IP	Material	EAN code
1464	12 x SMD 2835	10W	800LM	4500K	145 x 80 x 50	150	65	Aluminum + tempered glass	 5 908263 384644 >
4430	24 x SMD 2835	20W	1600LM		155 x 102 x 50				 5 908263 384651 >
5795	36 x SMD 2835	30W	2400LM		170 x 116 x 50	300			 5 908263 384668 >
5796	60 x SMD 2835	50W	4000LM		200 x 160 x 50				 5 908263 384675 >
1446	120 x SMD 2835	100W	8000LM		225 x 250 x 50				 5 908263 384682 >





-  Naświetlacze robocze LED
-  LED working floodlights
-  LED-Arbeitsscheinwerfer
-  LED-es munkalámpák



Index	 Source of light	 Power	 Brightness	 Colour Temperature	 Dimensions [mm]	 IP	 Material	EAN code
2874	36 x SMD 2835	2 x 30W	4800LM	5500K	154 x 114 x 28	65	Aluminum + tempered glass	 5 908263 384699 >
6982	60 x SMD 2835	1 x 50W	4000LM		189 x 142 x 32			 5 908263 385085 >
0805		2 x 50W	8000LM	189 x 142 x 32	 5 908263 384705 >			
7815	128 x SMD 2835	2 x 100W	16000LM	4500K	250 x 220 x 33			 5 904703 001454 >

ZESTAWY Z NAŚWIETLACZAMI LED TIGA

LED module 

-  Naświetlacze robocze LED
-  LED working floodlights
-  LED-Arbeitsscheinwerfer
-  LED-es munkalámpák



EAN code **8692**



5 904703 015420 >

EAN code **7816**



5 904703 001461 >







TO UNLOCK - TO LOCK



Index	Source of light	Power	Brightness	Colour Temperature	Dimensions [mm] floodlight	Dimensions [mm] handle	IP	Material
7816	SMD 2835	50W	4000LM	4500K	160 x 134 x 26	220 x 53 x 230	65	Aluminum + tempered glass
8692	SMD 2835	100W	8000LM		225 x 192 x 28	275 x 53 x 285		

LED module 

ZESTAWY Z NAŚWIETLACZAMI LED VEGA

-  Naświetlacze robocze LED
-  LED working floodlights
-  LED-Arbeitsscheinwerfer
-  LED-es munkalámpák



EAN code **1625**



5 908263 380905 >



EAN code **0311**



5 908263 380912 >



Index	Source of light	Power	Brightness	Colour Temperature	Dimensions [mm] floodlight	Dimensions [mm] handle	IP	Material
1625	36 x SMD 2835	30W	2400LM	4500K	116 x 102 x 26	180 x 150 x 285	65	Aluminum + tempered glass
0311	60 x SMD 2835	50W	4000LM		160 x 134 x 26	225 x 170 x 330		

-  Naświetlacze LED
-  LED floodlights
-  LED-Flutlicht
-  LED reflektorok



1660

EAN code



5 904703 012283 >









1659

EAN code



5 904703 012269 >



Index	 Source of light	 Power	 Brightness	 Colour Temperature	 Dimensions [mm]	 IP	 Material
1659	12 x SMD 2835	50W	5000LM	5000K	210 x 160 x 25	65	Aluminum + PC
1660	24 x SMD 2835	100W	10 000LM		270 x 208 x 25		

NAŚWIETLACZ LED NEVES

-  Naświetlacze LED
-  LED floodlights
-  LED-Flutlicht
-  LED reflektorok



4142



6563

















5125



5124



Index	 Source of light	 Power	 Brightness	 Colour Temperature	 Dimensions [mm]	 IP	 Material	EAN code
6563	12 x SMD 2835	50W	80lm/W	4500K	178 x 145,5 x 28,5	65	Aluminum + tempered glass	 5 908263 383425 >
5125	12 x SMD 2835	50W	80lm/W	6500K	178 x 145,5 x 28,5			 5 904703 006954 >
4142	24 x SMD 2835	100W	90lm/W	4500K	260 x 249 x 30			 5 904703 006923 >
5124	24 x SMD 2835	100W	80lm/W	6500K	260 x 249 x 30			 5 904703 006947 >

-  Naświetlacze robocze LED
-  LED working floodlights
-  LED-Arbeitsscheinwerfer
-  LED-es munkalámpák



1221 EAN code



5 903002 036341 >

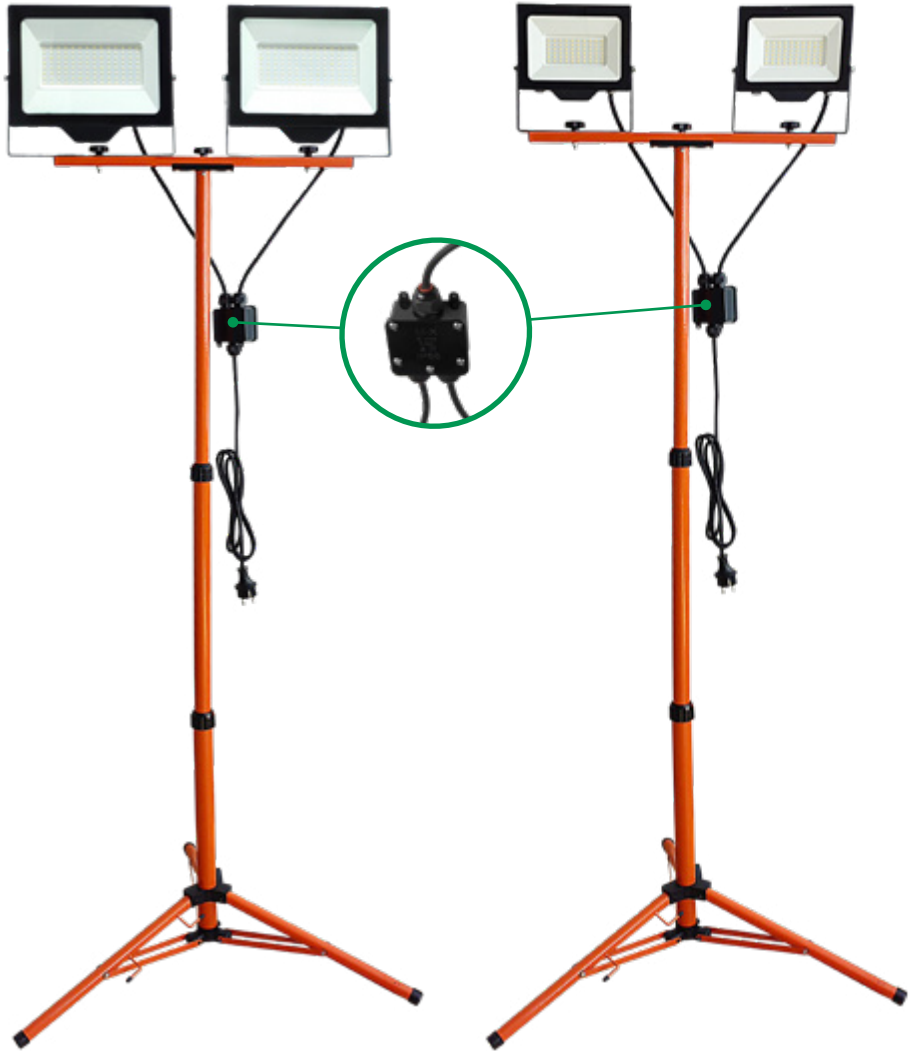

1481 EAN code















5 903002 037348 >

1482 EAN code



5 903002 037355 >

Index	 Source of light	 Power	 Brightness	 Colour Temperature	 Dimensions [mm] floodlight	 Dimensions [mm] tripod	 IP	 Material
1221	SMD 2835	50W	4000LM	4500K	220 x 205 x 325	-	65	Aluminum + tempered glass
1481	SMD 2835	2 x 100W	16000LM		260 x 249 x 30	1600		
1482	SMD 2835	2 x 50W	8000LM		178 x 145 x 28	1600		

-  Naświetlacze robocze LED
-  LED working floodlights
-  LED-Arbeitscheinwerfer
-  LED-es munkalámpák



EAN code **1663**



5 904703 012290 >



1733 EAN code



5 904703 012313 >



1/1

EAN code **3533** **New 2025**



5 904703 005308 >

H05RN-F (rubber) - 150cm (3x0,75 mm²)



1/2

EAN code **0356** **New 2025**



5 904703 005315 >

H05RN-F (rubber) - 200cm (3x0,75 mm²)











1/3

EAN code **5293** **New 2025**



5 904703 005322 >

H05RN-F (rubber) - 200cm (3x0,75 mm²)

Index	 Prąd wejściowy	 Power	 Brightness	 Colour Temperature	 Wymiary [mm] naświetlacza	 Wymiary [mm] statywu	 IP	 Material
1663	180-240V AC 50/60Hz	50W	5000LM	5000K	170 x 130 x 22	-	65	Aluminum + PC
1733		2 x 50W	10000LM		210 x 160 x 25	1600		

STATYW CLASSIC DO NAŚWIETLACZA

- Statyw do naświetlacza
- Floodlight stand
- Stativ für Doppellichter
- Állvány reflektorhoz



EAN code **1900**

5 903002 039595 >



UCHWYT HATLOGENU PRZENOŚNEGO



EAN code **1257**

5 903002 039663 >



TORBA DO NAŚWIETLACZY

EAN code **1731**

5 904703 012436 >
tripod type: double



EAN code **0962**

5 908263 382268 >
tripod type: double



EAN code **6777**

5 908263 385573 >
tripod type: single







EAN code **6998**

5 908263 385412 >
tripod type: double



width of crossbeam [mm]	height max. [mm]	Material
500	1600	Metal

-  Naświetlacze robocze LED
-  LED working floodlights
-  LED-Arbeitsscheinwerfer
-  LED-es munkalámpák



TO UNLOCK - TO LOCK



AKUMULATOROWE



0611



4998















0007







0127



Index	 Source of light	 Power	 Brightness	 Colour Temperature	 Dimensions [mm] floodlight	 Dimensions [mm] handle	 IP	 Material	EAN code
0611	SMD 2835	30W	5100LM	4500K	160 x 186 x 37	293 x 235 x 60	65	Aluminum + tempered glass	 5 904703 006695 >
4998		50W	8500LM		187 x 217 x 37	320 x 260 x 60			 5 903002 038772 >
0007		100W	17000LM		216 x 252 x 37	350 x 290 x 60			 5 903002 030967 >
0127		150W	25500LM		240 x 280 x 37	390 x 315 x 60			 5 908263 382275 >

ZŁĄCZA HERMETYCZNE

-  Złącze hermetyczne
-  Hermetic triple connector
-  Hermetischer Stecker
-  Hermetikus csatlakozó

9018 New 2025

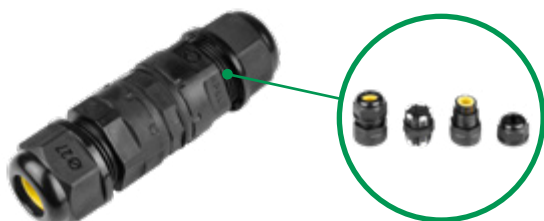

9019 New 2025



0525



0526





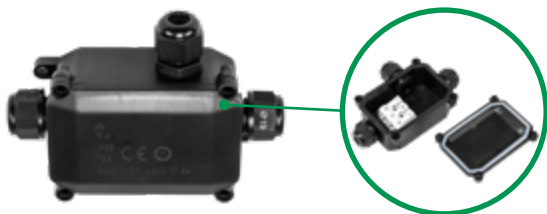

0604

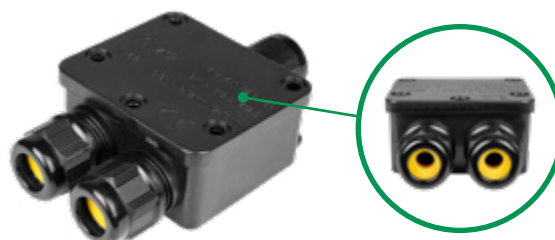





8073



Index	Choke bore diameter [mm]	 Dimensions [mm]	Number of strands	 IP	 Material	EAN code
9018	10	Ø31 x 101	5	68	ANTI-UV PA66	 5 904703 017912 >
9019	10	Ø26 x 83	3	68	ANTI-UV PA66	 5 904703 017905 >
0525	8	110 x 35 x 29	3	67	ANTI-UV PC	 5 904703 001355 >
0526		Ø22 x 72		68	ANTI-UV PA66	 5 904703 001362 >
0604	8,5	120 x 62 x 39		65	ANTI-UV PA66	 5 904703 001379 >
8073	11	120 x 72 x 39		68	ANTI-UV PA66	 5 904703 005339 >





-  Lampa Uliczna LED
-  Street Lamp LED
-  Straßenlaterne LED
-  Utcai lámpa LED



Index	Source of light	Power	Brightness	Colour Temperature	Dimensions [mm]	Diameter [mm]	IP	Material	EAN code
3322	SMD LED	30W	3 000LM	5000K	380 x 50 x 62	50	65	Aluminum + PC	 5 904703 006732 >
6529		50W	5 000LM		380 x 50 x 62				 5 908263 383418 >
4141		100W	10 000LM		480 x 65 x 73	 5 903002 039618 >			
1488		150W	15 000LM		570 x 99 x 73	60			 5 903002 039533 >
1473		200W	20 000LM		622 x 217 x 73	 5 903002 039526 >			

LAMPA ULICZNA LED VC



LED module 





-  Lampa Uliczna LED
-  Street Lamp LED
-  Straßenlaterne LED
-  Utcai lámpa LED



Regulation



Index	Source of light	Power	Brightness	Colour Temperature	Dimensions [mm]	Diameter [mm]	IP	Material	EAN code
3765	SMD 2835	100W	13 000LM (130 LM/W)	4500K	566 x 184 x 96	60	65	Aluminum + tempered glass	 5 904703 012207 >
3259		150W	19 500LM (130 LM/W)		625 x 208 x 97				 5 904703 012214 >
3185		200W	26 000LM (130 LM/W)		700 x 238 x 96				 5 904703 012221 >

-  Lampa LED parkowa latarnia
-  LED park lamp
-  LED-Parkleuchte
-  LED parkolólámpa



Ø60 [mm]
Inner diameter
onto lamp pole

New 2025

9282

EAN code



5 904703 019114 >



Ø60 [mm]
Inner diameter
onto lamp pole

New 2025

9283

EAN code



5 904703 019336 >



Ø60 [mm]
Inner diameter
onto lamp pole

New 2025

9284

EAN code



5 904703 019121 >

Index	Source of light	Power	Brightness	Colour Temperature	Dimensions [mm]	Diameter [mm]	IP	Material
9282	LED SMD 2835	60W	5 155LM	4000K	Ø380 x 120	60	65	Aluminum + tempered glass
9283		120W	10 465LM		Ø380 x 120			
9284	LED SMD 3030	60W	7 200LM		Ø450 x 524			Aluminum + PC

LED PARK LAMP TIRANA / PLEXIO

E27

- Lampa LED parkowa latarnia
- LED park lamp
- LED-Parkleuchte
- LED parkolólámpa

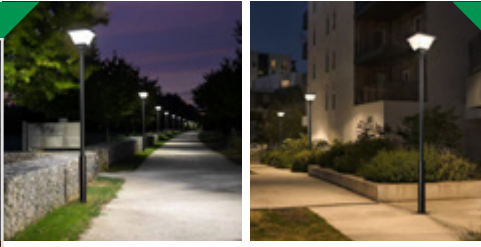

Ø60 [mm]
Inner diameter
onto lamp pole



New 2025

9315

EAN code



5 904703 018971 >



Ø76 [mm]
Inner diameter
onto lamp pole



New 2025

9317

EAN code



5 904703 018957 >



Ø76 [mm]
Inner diameter
onto lamp pole



New 2025

9316





EAN code



5 904703 018964 >

Index	Source of light	Max. power	Light distribution angle	Input current	Dimensions [mm]	Diameter [mm]	IP	Material
9315					320 x 320 x 330	60		
9316	LED E27 bulb (not included)	50W	360°	85-265V AC 50/60Hz	400 x 400 x 410	76	65	Aluminum + PC
9317					410 x 410 x 383			

SŁUP OŚWIETLENIOWY

-  Słup oświetleniowy
-  Lighting pole
-  Lichtmast
-  Világítóoszlop

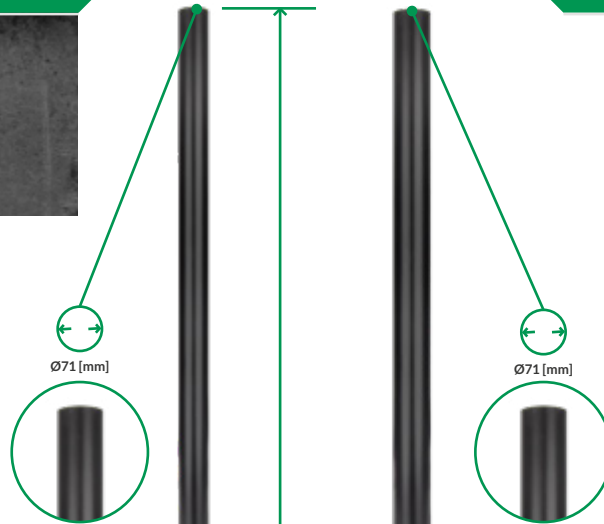

EAN code 1886



5 904703 007838 >

2634 EAN code





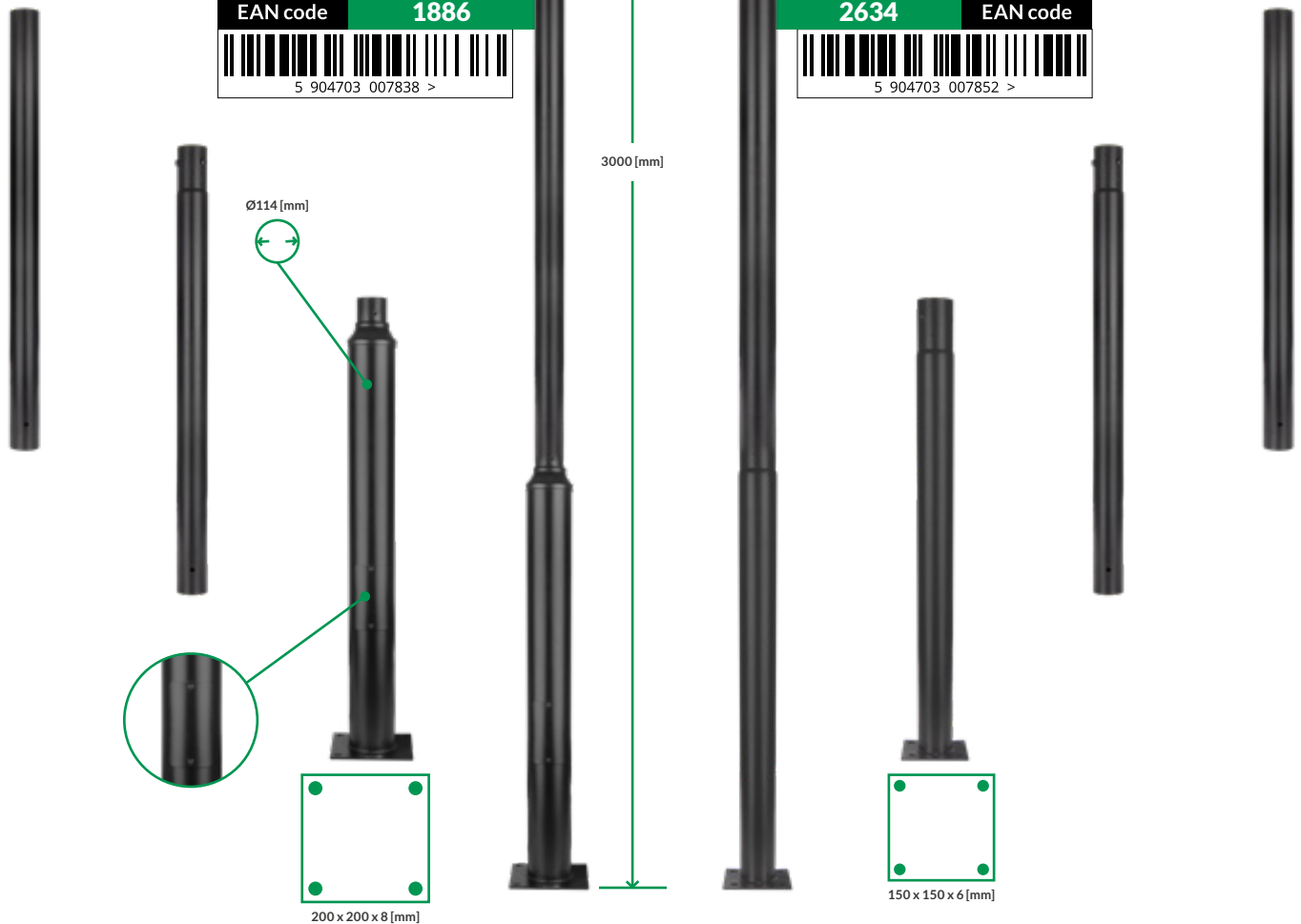

5 904703 007852 >



Index	Overall height [mm]	Base diameter [mm]	Revision	Tube diameter [mm]	Termination diameter [mm]	Base dimensions [mm]	Material
1886	3000	Ø114	Yes	Ø76	Ø71	200 x 200 x 8	Galvanized steel Q235
2634		Ø76	No		Ø71	150 x 150 x 6	

SŁUP OŚWIETLENIOWY

-  Słup oświetleniowy
-  Lighting pole
-  Lichtmast
-  Világítóoszlop



Ø55 [mm]



Ø55 [mm]



3000 [mm]

EAN code **8602**



5 904703 012962 >

8603 EAN code



5 904703 012993 >

Ø114 [mm]

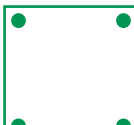

200 x 200 x 8 [mm]

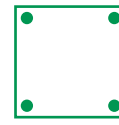

150 x 150 x 6 [mm]

Index	Overall height [mm]	Base diameter [mm]	Revision	Tube diameter [mm]	Termination diameter [mm]	Base dimensions [mm]	Material
8602	3000	Ø114	Yes	Ø76	Ø55	200 x 200 x 8	Galvanized steel Q235
8603		Ø76	No		Ø55	150 x 150 x 6	

AKCESORIA DO SŁUPA OŚWETLENIOWEGO

- Akcesoria do słupa oświetleniowego
- Accessories for lighting pole
- Zubehör für Lichtmasten
- Világítóoszlop tartozékok

New 2025

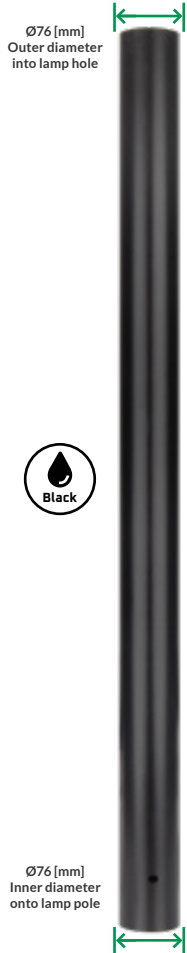

9233 EAN code

5 904703 018995 >

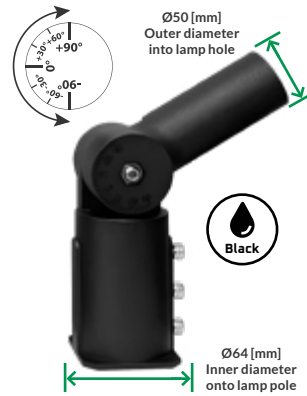

9234 EAN code

5 904703 019008 >



9235 EAN code

5 904703 019015 >

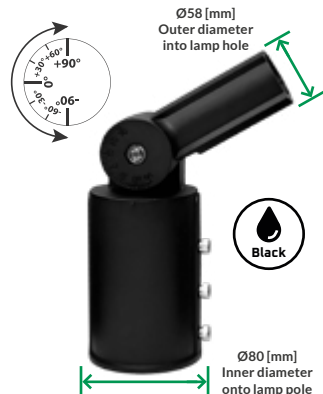

9236 EAN code

5 904703 019022 >

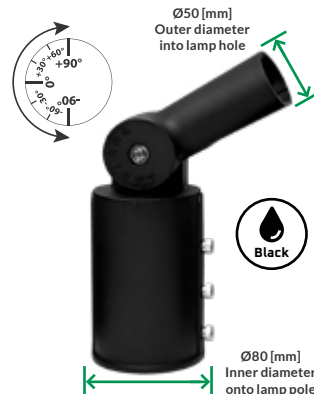

9241 EAN code

5 904703 019039 >



9243 EAN code

5 904703 019527 >

Index	Max. lifting capacity	Angle of inclination	Dimensions [mm]	Reduction [mm]	Material
2775	-	-	Ø76 x 1100	-	Galvanized steel Q235
9233	15 [kg]	-90° - +90° (adjustable)	Ø72 x 242	Ø64 to Ø43	Aluminum + stainless steel bolts
9234	18 [kg]		78 x 78 x 285	Ø64 to Ø50	
9235			78 x 78 x 285	Ø64 to Ø58 [mm]	
9236	25 [kg]		100 x 104 x 320	Ø80 to Ø58 [mm]	
9241			98 x 103 x 320	Ø80 to Ø50 [mm]	
6457	22 [kg]		-	Ø108 x 210	

KOTWA DO SŁUPA OŚWIETLENIOWEGO

- Kotwa do słupa oświetleniowego
- Anchor for a lighting pole
- Anker für einen Lichtmast
- Horgony világítóoszlophoz



EAN code **2671**

5 904703 007869 >



EAN code **2304**

5 904703 007845 >

Index	Fits on a light pole	Dimensions [mm]	Screw spacing [mm]	Steel thickness [mm]	Material
2671	2634, 8603	150 x 150 x 300	100 x 100	14	Steel
2304	1886, 8602	160 x 160 x 300	160 x 160		

UCHWYT DO LAMPY ULICZNEJ

- Uchwyt do lampy ulicznej
- Street lamp handle
- Halterung für Straßenlaterne
- Utcai lámpatartó

Required pipe diameter: 38-48 mm



3362



Required pipe diameter: 58 mm



6681



0664



1619







1628



Index	Fits the index	Dimensions [mm]	Pipe diameter [mm]	Angle of inclination	Material	EAN code
3362	3016 or 1619	140 x 69 x 25	Ø38-48	-	Steel	 5 903002 035719 >
6681	1628	150 x 80 x 25	Ø58	-		 5 908263 384040 >
0664	-	400 x 160	Ø50	90°		 5 908263 386891 >
1619	3362	500 x 140 x 70	Ø48	35-40°		 5 908263 384026 >
1628	6681	500 x 150 x 80	Ø58	35-40°		 5 908263 384033 >





-  Latarka LED
-  LED flashlight
-  LED-Taschenlampe
-  LED-es zseblámpa



Index	Power supply	Power	Brightness	Colour Temperature	Dimensions [mm]	IP	Material	EAN code
0479	2 x 18650 (not included)	3W	240LM	6000K	80 x 60 x 80	X2	Aluminum	 5 904703 009429 >
0478	2 x 18650 (not included)	5W T6 CREE + 3W 2XPE CREE	450LM		120 x 110 x 970		Aluminum + ABS	 5 904703 009375 >
0475	1200mAh (included)	3W COB + 1W LED	COB - 240LM, LED - 80LM		55 x 35 x 100		Silicone	 5 904703 009238 >
0477	3 x AAA (LR03 - not included)	3W COB	240LM		60 x 40 x 44		ABS	 5 904703 009160 >

LATARKA LED

LED module 

-  Latarka LED
-  LED flashlight
-  LED-Taschenlampe
-  LED-es zseblámpa



0472



2245





0471







New 2025

3424



Index	Power supply	Power	Brightness	Colour Temperature	Dimensions [mm]	Dimensions unfolded [mm]	IP	Material	EAN code
0472	1 x 18650 1200mAh (included)	3W COB + 1W LED	3W COB - 240LM, 1W LED - 80LM	6000K	148 x 48 x 35	270 x 48 x 35	X2	ABS + Rubber	 5 904703 009511 >
2245	3 x AAA (LR03 - not included)	3W COB + 1W LED	3W COB - 240LM, 1W LED - 80LM		140 x 45 x 40	255 x 45 x 40		ABS	 5 904703 009146 >
0471	1 x 18650 1200mAh (included)	3W COB + 1W LED	COB 3W - 240LM, LED 1W - 80LM		215 x 50 x 35			ABS + Rubber	 5 904703 009450 >
3424	4 x AAA (not included)	3W COB	230LM		206 x 52 x 25			20	ABS + Rubber

-  Latarka LED
-  LED flashlight
-  LED-Taschenlampe
-  LED-es zseblámpa



0474



0473



0480



0481

EAN code



5 904703 009597 >

18650 Li-Ion 1200mAh 3,7V



0482

EAN code



5 904703 009610 >

18650 Li-Ion 2200mAh 3,7V





0483

EAN code



5 904703 009627 >

18650 Li-Ion 3450mAh 3,6V

Index	Power supply	Power	Brightness	Colour Temperature	Dimensions [mm]	Dimensions unfolded [mm]	IP	Material	EAN code
0474	1x 18650 or adapter for 3xAAA (LR03) (not included)	3W LED	240LM	6000K	125 x 33 x 27	-	X2	Aluminum	 5 904703 009115 >
0473	1x 18650 1200mAh (included)	2W LED + 3W COB	LED - 160LM, COB - 240LM		60 x 140 x 185	-		ABS	 5 904703 009153 >
0480	3x AA (LR06)	3W COB	240LM		125 x 85 x 85	180 x 85 x 85		Plastic + steel	 5 904703 009214 >

LAMPA ULICZNA LED SOLARNA

LED module 

-  Lampa LED solarna
-  LED solar lamp
-  LED-Solarlampe
-  Solar LED lámpa



CONTROL BY IR REMOTE CONTROL



New 2025

9159





EAN code



5 904703 019213 >

Index	Source of light	Power	Brightness	Colour Temperature	Dimensions [mm]	Panel dimensions [mm]	IP	Material
9159	104 x SMD 2853	400W	8000LM	6000K	520 x 200 x 90	530 x 350 x 17	65	Aluminum

New 2025

-  Lampa LED solarna
-  LED solar lamp
-  LED-Solarlampe
-  Solar LED lámpa



9160

EAN code



5 904703 019220 >



9158

EAN code



5 904703 019206 >



9163

EAN code



5 904703 019251 >



EAN code

9161



5 904703 019237 >



EAN code

9162



5 904703 019244 >







CONTROL BY IR REMOTE CONTROL

Index	Source of light	Power	Brightness	Colour Temperature	Dimensions [mm]	Bore diameter [mm]	Motion Sensor	IP	Material
9160	84 x 2835 SMD LED	50W	800LM	6000K	357 x 134 x 55	30	Yes	65	ABS
9158	66 x 5050 SMD LED	100W	1500LM		439 x 236 x 64				
9161	109 x 5050 SMD LED	200W	2300LM		559 x 236 x 64				
9162	169 x 5050 SMD LED	300W	3900LM		689 x 237 x 64				
9163	139 x 5050 SMD LED	400W	5600LM		531 x 340 x 82				

LAMPA ULICZNA LED SOLARNA

LED module 

-  Lampa LED solarna
-  LED solar lamp
-  LED-Solarlampe
-  Solar LED lámpa



2350

EAN code



5 904703 007029 >



2404

EAN code



5 904703 007043 >



EAN code

2355



5 904703 007036 >



EAN code









2356



5 904703 007050 >



CONTROL BY IR REMOTE CONTROL

Index	 Source of light	 Power	 Brightness	 Colour Temperature	 Dimensions [mm]	 Bore diameter [mm]	 Motion Sensor	 IP	 Material
2350	100 x 5730 SMD LED	100W	1200LM	6000K	384 x 207 x 57	48-50	Yes	65	ABS
2404	200 x 5730 SMD LED	200W	2400LM		476 x 235 x 57				
2355	300 x 5730 SMD LED	300W	4200LM		618 x 256 x 57				
2356	400 x 5730 SMD LED	400W	6200LM		720 x 256 x 57				

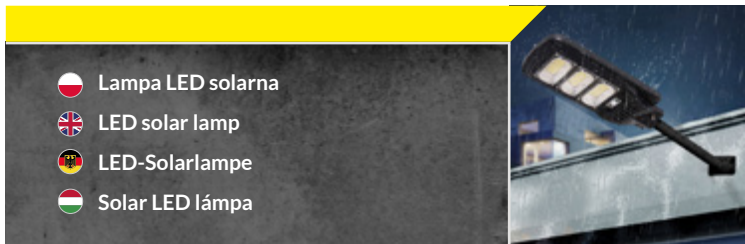

1191

EAN code



5 908263 383968 >



1198

EAN code



5 908263 383975 >



EAN code

1354



5 908263 383982 >



EAN code

1438



5 908263 383999 >



CONTROL BY IR REMOTE CONTROL

Index	Source of light	Power	Brightness	Colour Temperature	Dimensions [mm]	Bore diameter [mm]	Motion Sensor	IP	Material
1191	96 x 5730 SMD LED	100W	2000LM	6000K	485 x 220 x 60	48-50	Yes	65	ABS
1198	144 x 5730 SMD LED	150W	3000LM		620 x 240 x 60				
1354	270 x 5730 SMD LED	270W	6000LM		630 x 250 x 60				
1438	360 x 5730 SMD LED	360W	8000LM		730 x 250 x 60				

LAMPA LED SOLARNA LATARNIA

LED module 

-  Lampa LED solarna
-  LED solar lamp
-  LED-Solarlampe
-  Solar LED lámpa

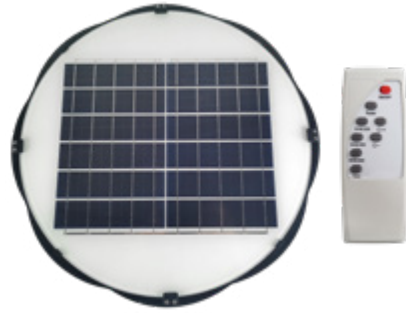
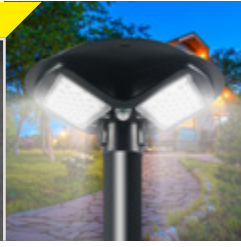

0277 - 4 MODULES











7145 - 3 MODULES



Ø76 (mm)







CONTROL BY IR REMOTE CONTROL

Index	 Source of light	 Power	 Brightness	 Colour Temperature	 Dimensions [mm]	 Motion Sensor	 IP	 Material	EAN code
7145	210 x 2835 SMD LED	150W	7500LM	5000K	Ø430 x 126	Yes	65	ABS	 5 908263 386877 >
0277	280 x 2835 SMD LED	200W	10000LM		Ø460 x 126				 5 908263 386884 >

LED module 

LAMPA LED SOLARNA

-  Lampa LED solarna
-  LED solar lamp
-  LED-Solarlampe
-  Solar LED lámpa



New 2025







CONTROL BY IR REMOTE CONTROL

Index	Source of light	Power	Brightness	Colour Temperature	Dimensions [mm]	Motion Sensor	IP	Material	EAN code
9271	210 x LED	12W	500LM	6500K	135 x 70 x 350	Yes	44	PC	 5 904703 018834 >

LAMPA LED SOLARNA

LED module 

-  Lampa LED solarna
-  LED solar lamp
-  LED-Solarlampe
-  Solar LED lámpa







CONTROL BY IR REMOTE CONTROL

Index	Source of light	Power	Brightness	Colour Temperature	Dimensions [mm]	Motion Sensor	IP	Material	EAN code
3656	300 x 5730 SMD LED	300W	4200LM	6000K	618 x 256 x 57	Yes	65	ABS	 5 904703 014164 >

LAMPA LED SOLARNA

LED module 

-  Lampa LED solarna
-  LED solar lamp
-  LED-Solarlampe
-  Solar LED lámpa



New 2025



EAN code **9252**



5 904703 018841 >



CONTROL BY IR REMOTE CONTROL



EAN code **7115**



5 908263 383814 >



EAN code **1783**













5 904703 006206 >



CONTROL BY IR REMOTE CONTROL



Index	 Source of light	 Power	 Brightness	 Colour Temperature	 Dimensions [mm]	 Motion Sensor	 IP	 Material
7115	36 x SMD 2835	5W		5500-6000K	250 x 80 x 40		65	ABS
1783	100 x dioda LED	10W	300LM	6500K	125 x 205 x 365	Yes	44	Plastic
9252	54 x LED	3,2W			95 x 63 x 230			PC

-  Lampa LED solarna
-  LED solar lamp
-  LED-Solarlampe
-  Solar LED lámpa

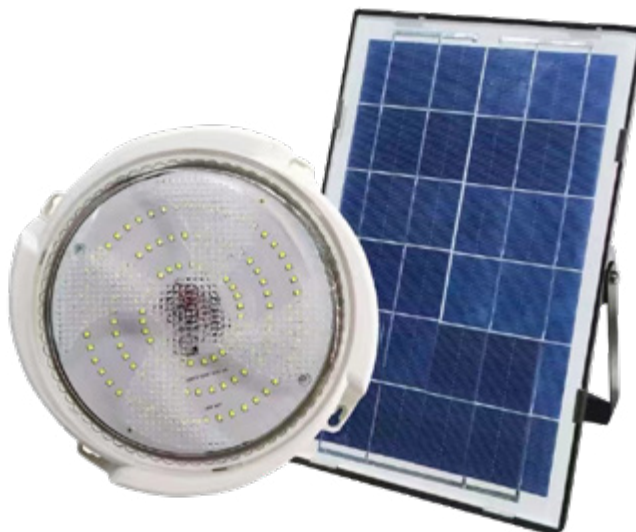
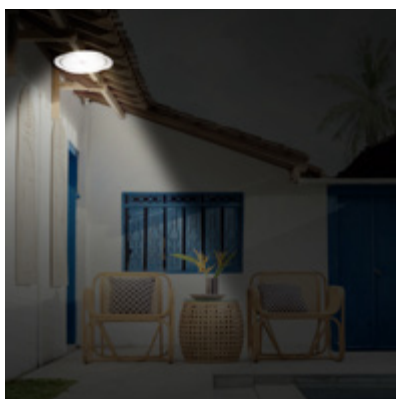

CONTROL BY IR REMOTE CONTROL

New 2025

9164

EAN code



5 904703 019268 >











CONTROL BY IR REMOTE CONTROL

4159

EAN code



5 904703 013211 >

Index	 Source of light	 Power	 Brightness	 Colour Temperature	 Dimensions [mm]	 Panel dimensions [mm]	 IP	 Material
9164	54 x 2835 SMD LED	50W	900LM	5000K	Ø190 x 60	180 x 270 x 15	65	ABS
4159	2835 x 120PCS x 1W	120W	2800LM		Ø237 x 60	235 x 350 x 17	65	PC

LAMPA LED SOLARNA

LED module 

-  Lampa LED solarna
-  LED solar lamp
-  LED-Solarlampe
-  Solar LED lámpa



0300 EAN code



5 904703 008279 >







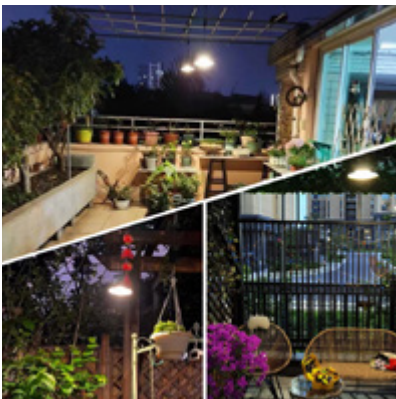

0304 EAN code



5 904703 008255 >



Index	 Source of light	 Power	 Brightness	 Colour Temperature	 Dimensions [mm]	 IP	 Material
0300	LED	1,8W	100LM	6500K	70 x 180	44	ABS + PC
0304		2 x 1,8W	200LM				

-  Lampa LED solarna
-  LED solar lamp
-  LED-Solarlampe
-  Solar LED lámpa



230V





HYBRID: SOLAR + 230V

Index	Source of light	Power	Brightness	Colour Temperature	Dimensions [mm]	IP	Material	EAN code
3375	2835 x 312PCS x 0.5W	200W	4500LM	5000K	290 x 250 x 55	44	Aluminum	 5 904703 013204 >

LAMPA LED SOLARNA

LED module 

-  Lampa LED solarna
-  LED solar lamp
-  LED-Solarlampe
-  Solar LED lámpa



CONTROL BY IR REMOTE CONTROL

New 2025

9222

EAN code



5 904703 019497 >



CONTROL BY IR REMOTE CONTROL









New 2025

9223

EAN code

















5 904703 019503 >

Index	 Source of light	 Power	 Brightness	 Colour Temperature	 Dimensions [mm]	 Panel dimensions [mm]	 IP	 Material
9222	56 x 2835 SMD LED	100W	500LM	4500K	170 x 193 x 40	220 x 200 x 150	IP65 IK06	ABS + PC
9223	100 x 2835 SMD LED	100W	1000LM	4500K	205 x 217 x 37	290 x 350 x 17		Aluminum + PC

-  Naświetlacz LED solarny
-  LED solar floodlight
-  LED-Solar-Flutlicht
-  Solar LED reflektor



Index	 Source of light	 Power	 Brightness	 Colour Temperature	 Dimensions [mm]	 Motion Sensor	 IP	 Material	EAN code
2458	LED SMD 2835	10W	200LM	4500K	165 x 145 x 30	Yes	54	ABS + tempered glass	 5 904703 009801 >
4438		20W	800LM						 5 904703 009818 >
4920		30W	1600LM						 5 904703 009825 >

-  Naświetlacz LED solarny
-  LED solar floodlight
-  LED-Solar-Flutlicht
-  Solar LED reflektor



New 2025



9620

EAN code



5 904703 020301 >

CONTROL BY IR REMOTE CONTROL

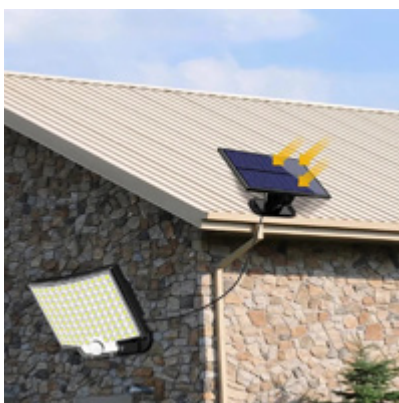

3651









EAN code







5 904703 014126 >

CONTROL BY IR REMOTE CONTROL



Index	 Source of light	 Power	 Brightness	 Colour Temperature	 Dimensions [mm]	 Motion Sensor	 IP	 Material
9620	210 x LED	12W	500LM	6000K	160 x 104 x 88 lamp 150 x 25 x 98 panel	Yes	44	PC
3651	108 x LED	10W	500LM	6500K	150 x 50 x 165 lamp 140 x 40 x 123 panel			

-  Naświetlacz LED solarny
-  LED solar floodlight
-  LED-Solar-Flutlicht
-  Solar LED reflektor



7307

EAN code



5 908263 387072 >



4363

EAN code



5 908263 387010 >















1361

EAN code



5 908263 387065 >

Index	 Source of light	 Power	 Brightness	 Colour Temperature	 Dimensions [mm]	 Motion Sensor	 IP	 Material
7307	74 x LED SMD	15W	450LM	5500-6000K	282 x 145 x 90			
4363	138 x SMD LED	10W	480LM	6500K	278 x 100 x 106	Yes	65	ABS
1361	78 x LED SMD	15W	450LM	5500K	220 x 130 x 144			

-  Naświetlacz LED solarny
-  LED solar floodlight
-  LED-Solar-Flutlicht
-  Solar LED reflektor



New 2025



9619

EAN code



5 904703 020295 >

CONTROL BY IR REMOTE CONTROL

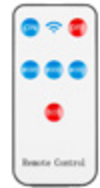

1593







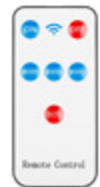

EAN code





5 908263 383807 >

CONTROL BY IR REMOTE CONTROL



Index	 Source of light	 Power	 Brightness	 Colour Temperature	 Dimensions [mm]	 Motion Sensor	 IP	 Material
9619	226 x LED SMD	10W	500LM	6000K	323 x 45 x 90 lamp 160 x 18 x 100 panel	Yes	44	ABS
1593	6 x COB PIR	4W	250LM	5500-6000K	150 x 110 x 40 lamp 130 x 130 x 35 panel		54	Plastic

-  Lampa LED solarna
-  LED solar lamp
-  LED-Solarlampe
-  Solar LED lámpa

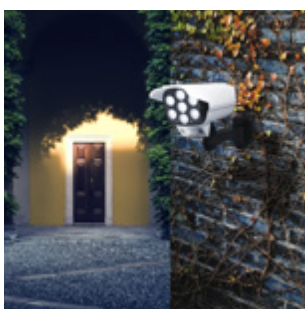

New 2025



EAN code **1296**



5 908263 387041 >



EAN code **1762**



5 904703 006190 >











EAN code **4541**



5 908263 387027 >



Index	 Source of light	 Power	 Brightness	 Colour Temperature	 Dimensions [mm]	 Motion Sensor	 IP	 Material
1296	63 x LED COB	12W	300LM	6000K	156 x 85 x 145	Yes	65	Plastic
1762	LED (100LED)	5W	250LM	6500K	210 x 200 x 80		65	ABS
4541	77 x SMD LED	8W	400LM		200 x 95 x 160		65	ABS

LAMPA LED SOLARNA

LED module 

-  Lampa LED solarna
-  Solar LED lamp
-  LED-Solarlampe
-  Solar LED lámpa



0602 EAN code



5 903002 034125 >



- 
- 
- 



6449 EAN code



5 908263 383463 >



0515 EAN code



5 903002 034101 >



- 
- 

0593 EAN code



5 903002 034118 >



- 
- 
- 









7165 EAN code



5 903002 037027 >



- 
- 
- 

Index	 Source of light	 Power	 Brightness	 Colour Temperature	 Dimensions [mm]	 Motion Sensor	 IP	 Material
0602	40 x LED	4W	150LM	6500K	195 x 45 x 120	Yes	44	Plastic
6449	30 x LED	3W	120LM		95 x 48 x 130			
0515	20 x SMD 2835	3W	200LM	5500-6000K	125 x 98 x 48	No	65	ABS
0593						Yes		
7165	100 x LED	10W	300LM	6500K	95 x 55 x 135	Yes	44	Plastic

-  Lampa LED solarna
-  Solar LED lamp
-  LED-Solarlampe
-  Solar LED lámpa



0565 EAN code

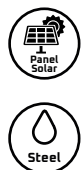

New 2025

9249 EAN code

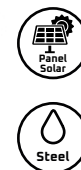

1478 EAN code



New 2025





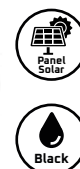
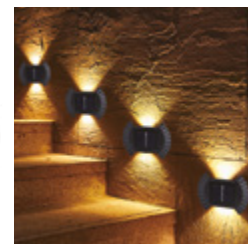



8850 EAN code



0624 EAN code



Index	 Source of light	 Power	 Brightness	 Colour Temperature	 Dimensions [mm]	 Motion Sensor	 IP	 Material
0565	2 x SMD LED	0,3W	20LM	5000K	100 x 75 x 30	No	65	ABS
9249	4 x LED SMD	0,24W	20LM	6500K	185 x 50 x 190	No	44	PC + steel
1478	LED SMD	0,1W	10LM	5500-6000K	200 x 180 x 30	No	65	Stainless steel
8850	1 x LED	0,2W	10LM	3200K	80 x 43 x 47	No	54	Plastic
0624	2 x SMD LED	0,3W	15LM	4500K	100 x 75 x 20	No	65	ABS

LAMPA LED SOLARNA

LED module 

-  Lampa LED solarna
-  Solar LED lamp
-  LED-Solarlampe
-  Solar LED lámpa



0299

EAN code



5 904703 008286 >



2125

EAN code



5 903002 033449 >

Index	Source of light	Power	Brightness	Colour Temperature	Dimensions [mm]	IP	Material
0299	1 x LED	1W	50LM	3000K	120 x 58 x 170	44	Plastic
2125	12 x LED	0,72W	20LM		90 x 65 x 115		

LED module 

LAMPA LED SOLARNA

-  Lampa LED solarna
-  Solar LED lamp
-  LED-Solarlampe
-  Solar LED lámpa

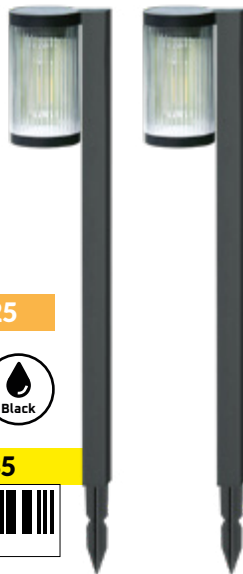

New 2025



EAN code

9835



5 904703 022640 >



New 2025



EAN code

9244



5 904703 018902 >

Index	Source of light	Power	Brightness	Colour Temperature	Dimensions [mm]	IP	Material
9835	1 x LED	0,5W	15LM	2500K	80 x 110 x 580	54	ABS + PC
9244		0,1W	10LM	3000K	Ø75 x 395	44	PC

-  Lampa LED solarna
-  Solar LED lamp
-  LED-Solarlampe
-  Solar LED lámpa



EAN code **0557**



EAN code **0567**



Index	Source of light	Power	Brightness	Colour Temperature	Dimensions [mm]	IP	Material
0557	1 x LED	1W	80LM	4000K	163 x 54 x 600	54	Aluminum + PC
0567	LED x 30PCS: SMD2835	1.5W	100-200LM		162 x 90 x 413	65	Plastic

LAMPA LED SOLARNA

-  Lampa LED solarna
-  Solar LED lamp
-  LED-Solarlampe
-  Solar LED lámpa



EAN code **0743**

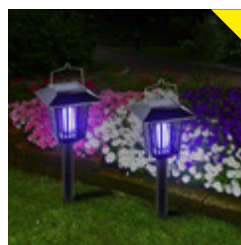

EAN code **3173**



Index	Source of light	Power	Brightness	Colour Temperature	Dimensions [mm]	IP	Material
0743	2 x LED	0,12W	12LM	6500K	170 x 1530	44	Plastic
3173		0,06W	10LM		150 x 150 x 580		

-  Lampa LED solarna
-  Solar LED lamp
-  LED-Solarlampe
-  Solar LED lámpa



9245 EAN code



5 904703 018896 >



9246 EAN code



5 904703 018889 >









9247 EAN code



5 904703 018872 >



Index	 Source of light	 Power	 Brightness	 Colour Temperature	 Dimensions [mm]	 IP	 Material
9245	LED	0,1W	20LM	3000K	Ø120 x 800	44	PC + steel
9246					Ø110 x 760		
9247	6 x LED	0,36W	30LM	Ø110 x 750			

-  Lampa LED solarna
-  Solar LED lamp
-  LED-Solarlampe
-  Solar LED lámpa



3174 EAN code



5 904703 014096 >

3660 EAN code



5 904703 014201 >

8848 EAN code









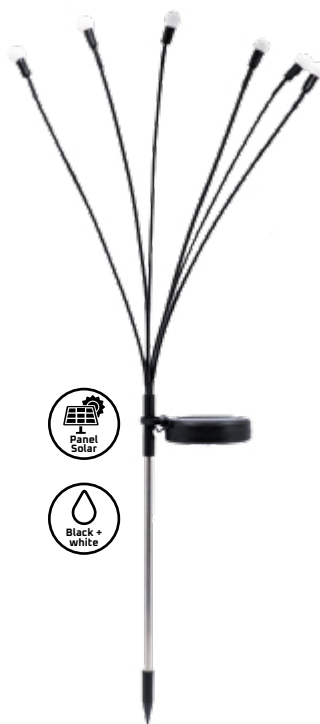

5 904703 016687 >

3659 EAN code



5 904703 014195 >



Index	 Source of light	 Power	 Brightness	 Colour Temperature	 Dimensions [mm]	 IP	 Material
3174	144 x dioda LED	2,9W	40LM	3000K	250 x 840	44	Plastic + copper wire
3660	6 x dioda LED	0,36W	20LM		730		Plastic
8848	8 x dioda LED	0,6W	25LM				
3659	10 x dioda LED	0,6W	25LM				

LAMPA LED SOLARNA

LED module 

-  Lampa LED solarna
-  Solar LED lamp
-  LED-Solarlampe
-  Solar LED lámpa



Ø200 [mm]

 Panel Solar

 Black

New 2025

9238 EAN code



5 904703 018940 >

Ø250 [mm]

 Panel Solar

 Black

New 2025

9239 EAN code



5 904703 018933 >

Ø300 [mm]

 Panel Solar

 Black

New 2025

9240 EAN code



5 904703 018926 >

Ø100 [mm]

 Panel Solar

 Black

EAN code 3435



5 903002 033463 >



Ø100 [mm]

 Panel Solar







 Black





New 2025

EAN code 9242



5 904703 018919 >

Index	 Source of light	 Power	 Brightness	 Colour Temperature	 Dimensions [mm]	 IP	 Material
9238	LED	0,24W	20LM	6500K	Ø200 x 525	44	PC
9239			20LM		Ø250 x 705		
9240			20LM		Ø300 x 755		
3435		0,06W	10LM	5500-6000K	Ø100 x 345		
9242		0,1W	8LM	3000K	Ø100 x 340		

-  Lampa LED solarna
-  Solar LED lamp
-  LED-Solarlampe
-  Solar LED lámpa

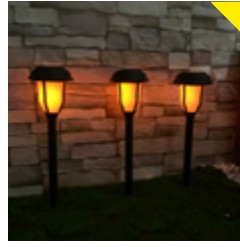

2007

EAN code



EAN code

2943



1313



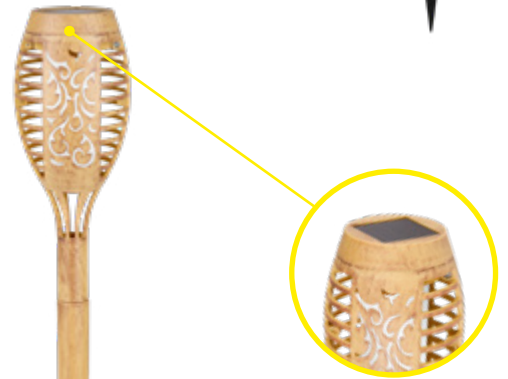



EAN code



3658

EAN code



Index	 Source of light	 Power	 Brightness	 Colour Temperature	 Dimensions [mm]	 IP	 Material
2007	LED SMD	1,2W	30LM	Imitation flame 3000K	65 x 65 x 390	44	ABS
2943	12 x LED	0,72W	20LM		100 x 100 x 405		Plastic
1313	12 x LED	0,72W	20LM		75 x 75 x 510		ABS
3658	12 x LED	0,72W	20LM		75 x 75 x 510		Plastic

LAMPA LED SOLARNA

LED module 

-  Lampa LED solarna
-  Solar LED lamp
-  LED-Solarlampe
-  Solar LED lámpa



 Panel Solar

 Black

0315 EAN code



5 904703 001324 >



 Panel Solar

 Black

3744 EAN code



5 903002 036297 >



 Panel Solar

 Black

EAN code **3276**



5 904703 001331 >



 Panel Solar

 Black

EAN code **4849**



5 903002 038840 >

Index	Source of light	Power	Brightness	Colour Temperature	Dimensions [mm]	IP	Material
0315	LED	0,6W	10LM	5500-6000K	Ø105 x 380	44	Plastic
3744		1W	50LM		50 x 50 x 380		
3276		0,06W	50LM	5500-6000K	Ø60 x 330		Plastic + glass
4849		1W	50LM		Ø46 x 255		Plastic + Stainless Steel

All indices in a package of 12 pcs.

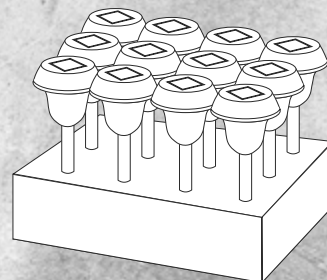

-  Lampa LED solarna
-  Solar LED lamp
-  LED-Solarlampe
-  Solar LED lámpa



EAN code 3653



5 904703 014140 >



EAN code 3652



5 904703 014133 >



EAN code 1370



5 903002 036143 >



3171 EAN code





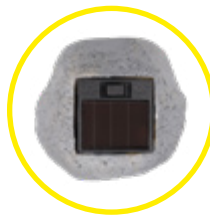



5 904703 014072 >



3655 EAN code



5 904703 014157 >

Index	 Source of light	 Power	 Brightness	 Colour Temperature	 Dimensions [mm]	 IP	 Material
3653	18 x LED	1,8W	100LM		160 x 100 x 260	44	Plastic
1370	4 x LED	0,8W	50LM	6500K	86 x 335		
3652	1 x LED	0,4W	50LM		110 x 130 x 420		
3171	1 x LED	0,06W	10LM	3000K	145 x 110 x 90		
3655	1 x LED	0,06W	5LM	6500K	85 x 65 x 60		Plastic+resin

LAMPA LED SOLARNA

LED module 

-  Lampa LED solarna
-  Solar LED lamp
-  LED-Solarlampe
-  Solar LED lámpa



EAN code **3645**



5 904703 014119 >

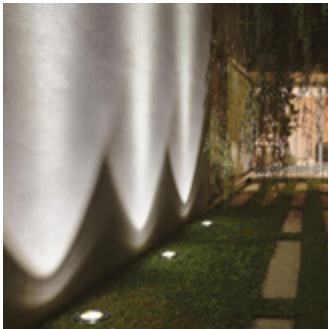

1582

EAN code



5 908263 380998 >

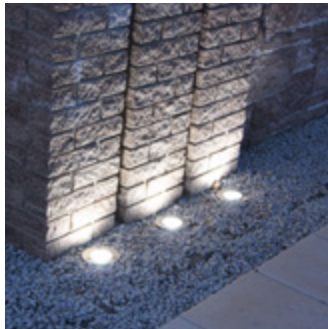

7126

EAN code



5 908263 381001 >



7130

EAN code



5 908263 383784 >









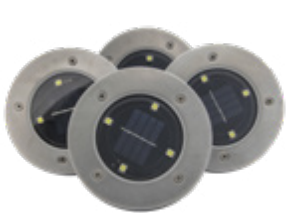

2460

EAN code



5 908263 383791 >



Index	 Source of light	 Power	 Brightness	 Colour Temperature	 Dimensions [mm]	 IP	 Material
3645	4 x LED	0,24W	20LM	6500K	4700	44	Plastic
1582	4 x SMD 5050 Powerchip	0,4W	20LM	5500-6000K	Ø 115 x 135	54	ABS + Stainless steel
7126	8 x SMD 5050 Powerchip	0,8W	35LM			44	Plastic + Stainless steel
7130	12 x SMD 5050 Powerchip	0,72W	30LM	6500K		44	Plastic + Stainless steel
2460	16 x SMD 5050 Powerchip	0,96W	40LM				

-  Girlanda LED solarna
-  LED solar garland
-  Solar-LED-Girlande
-  Solar LED füzér

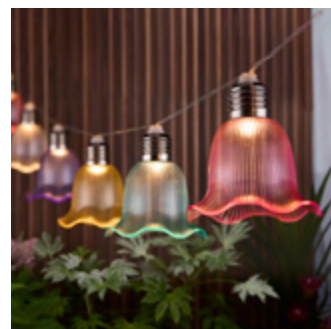
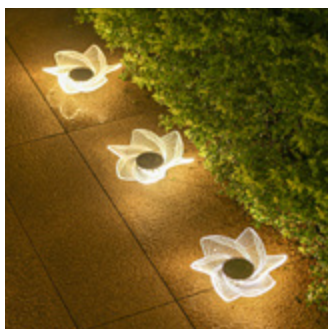

New 2025

9248

EAN code



5 904703 018865 >



New 2025

9272

EAN code



5 904703 018827 >



New 2025







9273

EAN code







5 904703 018810 >



Index	 Source of light	 Power	 Brightness	 Colour Temperature	 Dimensions [mm]	 IP	 Material
9248	12 x LED	0,72W	30LM	3000K	Ø150 x 160	44	PC
9272	20 x LED	1,2W			5800		
9273	10 x LED	0,6W	20LM		3800		

New 2025

-  Girlanda LED solarna
-  LED solar garland
-  Solar-LED-Girlande
-  Solar LED füzér

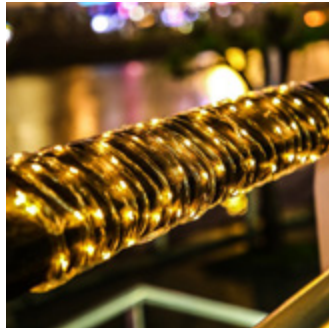

3780





3669





3668







3670





3665













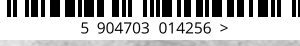
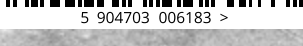

5004





Index	Source of light	Power	Brightness	Colour Temperature	Dimensions [mm]	IP	Material	EAN code
3780	100 x LED	1W	30LM	3000K	11 900	44	Plastic + Copper	 5 904703 014287 >
3670	200 x LED	4W	40LM		21 900			 5 904703 014270 >
3669	300 x LED	6W	50LM		31 900			 5 904703 014263 >
3665	400 x LED	8W	60LM		41 900			 5 904703 014249 >
3668	500 x LED	10W	70LM		51 900			 5 904703 014256 >
5004	100 x LED	1W	25LM		11 900		PVC	 5 904703 006183 >

-  Girlanda LED solarna
-  LED solar garland
-  Solar-LED-Girlande
-  Solar LED füzér



0637

20 x LED
Overall length: 485 cm

0736

10 x LED
Overall length: 335 cm

0138

20 x LED
Overall length: 485 cm



2288

40 x LED
Overall length: 785 cm







3161

20 x LED
Overall length: 485 cm



2291

40 x LED
Overall length: 785 cm

Index	Source of light	Power	Brightness	Colour Temperature	Dimensions [mm]	IP	Material	EAN code
0637	20 x LED DIP	0,72W	30LM	3000K	4850	44	PVC	 5 908263 387362 >
2288	40 x LED DIP	1,44W	60LM		7850			 5 904703 006145 >
0736	10 x LED DIP	0,72W	25LM		3350			 5 908263 387379 >
3161	20 x LED DIP	1,44W	50LM		4850			 5 904703 006169 >
0138	20 x LED DIP	0,72W	34LM		4850			 5 908263 387355 >
2291	40 x LED DIP	2,88W	100LM		7850			 5 904703 006152 >

GIRLANDA LED SOLARNA

LED module 

-  Girlanda LED solarna
-  LED solar garland
-  Solar-LED-Girlande
-  Solar LED füzér

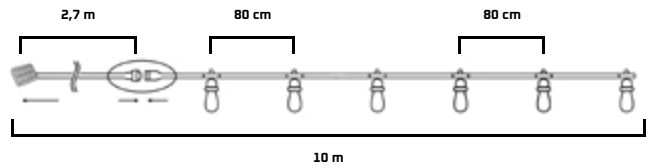

0305









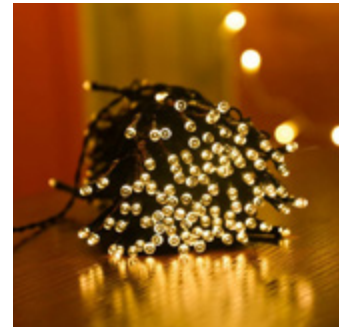



3644



3657



1860

Index	 Source of light	 Power	 Brightness	 Colour Temperature	 Dimensions [mm]	 IP	 Material	EAN code
0305	10 x S14 LED	3W	100LM	3000K	10 000	44	PC	 5 904703 008262 >
3644	10 x LED	0,6W	20LM		3350		Plastic	 5 904703 014102 >
3657	20 x LED	1,2W	30LM		4850		 5 904703 014171 >	
1860	100 x LED	1W	25LM		11 900		PVC	 5 904703 006138 >

-  Lampa LED solarna
-  Solar LED lamp
-  LED-Solarlampe
-  Solar LED lámpa





EAN code 3662



5 904703 014225 >





-  Panel Solar
-  Black

EAN code 3663

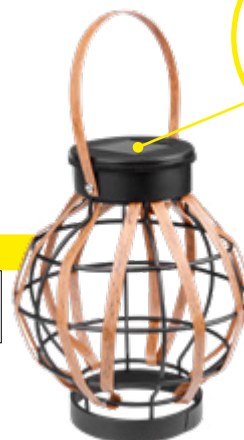

5 904703 014232 >



-  Panel Solar
-  Black + brown

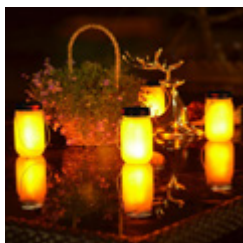



2902 EAN code



5 903002 033494 >



-  Panel Solar
-  Black

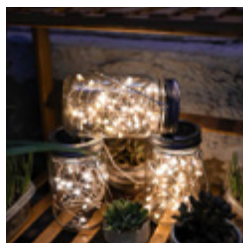



0745 EAN code



5 908263 387393 >



-  Panel Solar
-  Black











2522 EAN code







5 903002 031711 >



-  Panel Solar
-  Black

Index	 Source of light	 Power	 Brightness	 Colour Temperature	 Dimensions [mm]	 IP	 Material
3662	5 x LED	0,1W	20LM	3000K	130 x 130 x 160	44	Plastic + iron
3663	1 x LED	0,1W	20LM		150 x 150 x 180		Plastic + iron + rattan
2902	LED SMD	1,2W	30LM	Imitation flame	75 x 75 x 130		ABS + glass + stainless steel
0745	30 x LED	0,6W	20LM	3000K	75 x 75 x 130		Plastic + glass + stainless steel
2522	12 x LED	0,72W	20LM		90 x 90 x 170		Plastic

-  Lampa Robocza LED
-  LED Work Lamp
-  LED-Arbeitsleuchte
-  LED munkalámpa



10-30V DC

 100 x 85 x 18 mm

 27W

EAN code 3909



5 908263 380608 >



10-30V DC

 113 x 125 x 18 mm

 27W

EAN code 8840



5 904703 016694 >



10-30V DC

 110 x 110 x 25 mm

 90W

EAN code 2826



5 904703 015444 >



10-30V DC

 102 x 96 x 25 mm

 48W

EAN code 9472



5 904703 021384 >



10-30V DC

 105 x 85 x 18 mm

 48W

EAN code 3944



5 908263 380615 >



10-30V DC

 110 x 110 x 25 mm





 123W

EAN code 2825



5 904703 015437 >

-  Aluminum
-  6000K
-  Black
-  IP67

-  Lampa Robocza LED
-  LED Work Lamp
-  LED-Arbeitsleuchte
-  LED munkalámpa



10-30V DC

 110 x 110 x 35 mm

 54W

EAN code 8059



5 904703 005384 >



10-30V DC

 135 x 107 x 35 mm

 126W

EAN code 5047



5 908263 383647 >



10-30V DC

 110 x 80 x 35 mm

 54W

EAN code 7109



5 908263 385757 >



10-30V DC

 109 x 92 x 27 mm

 48W+2W

EAN code 9471



5 904703 021377 >



10-30V DC

 245 x 82 x 140 mm

 40W+20W

EAN code 9469



5 904703 021353 >



10-30V DC

 77 x 69 x 77 mm





 40W

EAN code 9470



5 904703 021360 >



-  Lampa Robocza LED
-  LED Work Lamp
-  LED-Arbeitsleuchte
-  LED munkalámpa



10-30V
DC

150 x 38 x
40 mm

18W

EAN code **5191**



5 903002 036914 >



10-30V
DC

165 x 80 x
65 mm

36W

EAN code **1229**



5 903002 036945 >



10-30V
DC

160 x 80 x
82 mm

120W

EAN code **4935**



5 908263 383593 >



10-30V
DC

90 x 80 x
62 mm





60W

EAN code **6447**



5 908263 383586 >



-  Lampa Robocza LED
-  LED Work Lamp
-  LED-Arbeitsleuchte
-  LED munkalámpa

10-30V DC  900 x 135 x 70 mm  460W

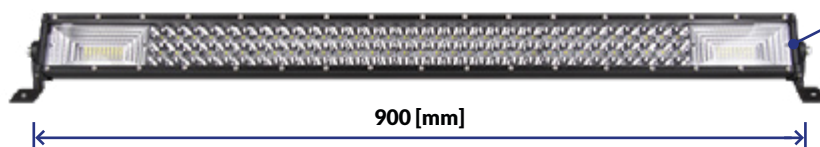

EAN code **0463**

 5 904703 009184 >

10-30V DC  1150 x 135 x 70 mm  550W

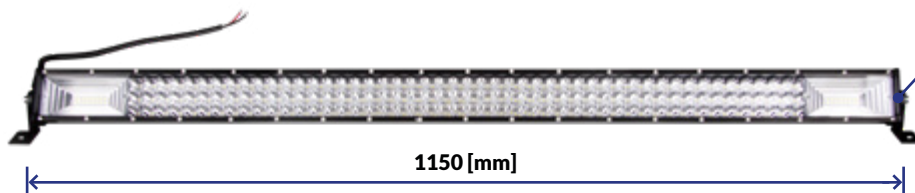

EAN code **0464**

 5 904703 009191 >

10-30V DC  540 x 135 x 70 mm  180W

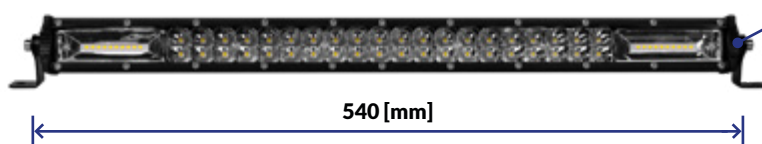

EAN code **0467**

 5 904703 009221 >





10-30V DC  800 x 75 x 55 mm  700W



EAN code **8060**

 5 904703 005391 >



-  Lampa Robocza LED
-  LED Work Lamp
-  LED-Arbeitsleuchte
-  LED munkalámpa



EAN code 2823



5 904703 014485 >

10-30V
DC

440 x 55 x
45 mm

48W



EAN code 2157



5 904703 014478 >

10-30V
DC

650 x 55 x
45 mm

72W

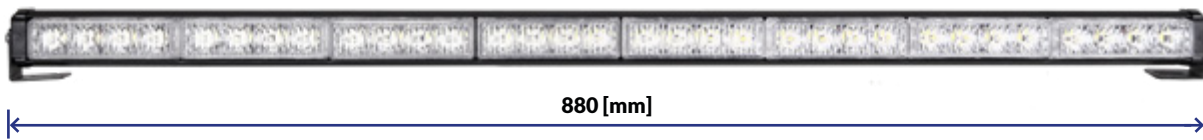

EAN code 2824



5 904703 014492 >





10-30V
DC

880 x 55 x
45 mm





96W

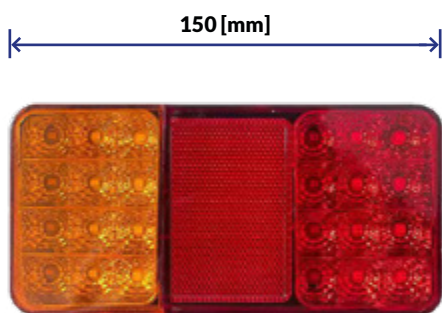

-  Aluminum
-  6000K
-  Black
-  IP67

-  Lampa Robocza LED
-  LED Work Lamp
-  LED-Arbeitsleuchte
-  LED munkalámpa



-  Lampa Robocza LED
-  LED Work Lamp
-  LED-Arbeitsleuchte
-  LED munkalámpa

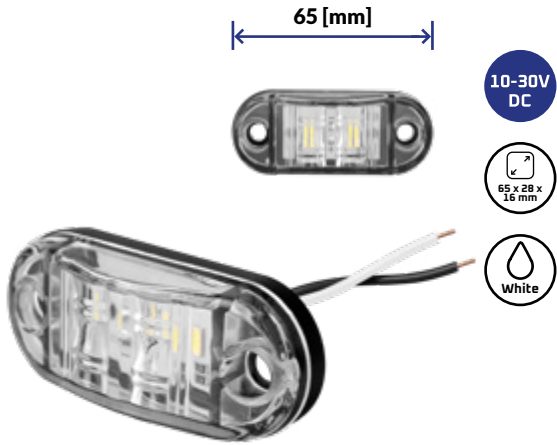
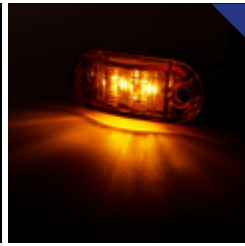
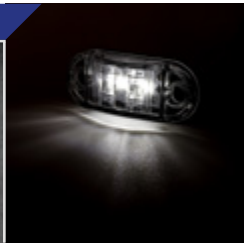

10-30V DC

65 x 28 x 16 mm

White

EAN code **6617**

 5 904703 014423 >

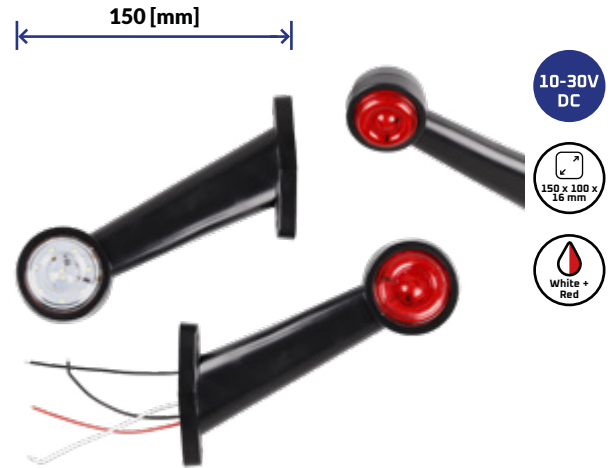

10-30V DC

150 x 100 x 16 mm

White + Red

EAN code **2828**

 5 904703 014430 >

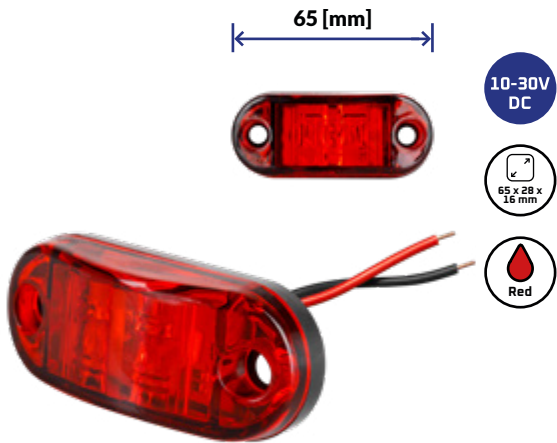

10-30V DC

65 x 28 x 16 mm

Red

EAN code **6618**

 5 904703 014416 >

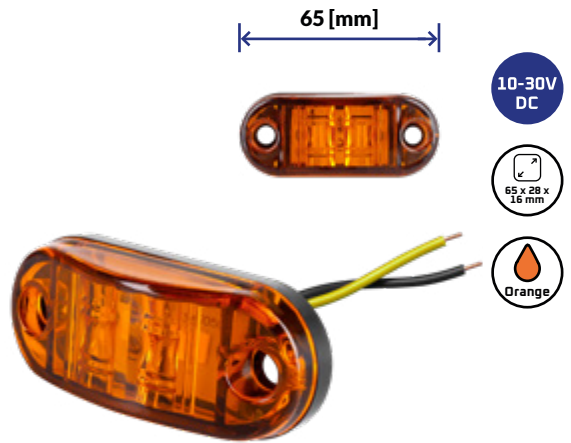

10-30V DC

65 x 28 x 16 mm





Orange

EAN code **6621**

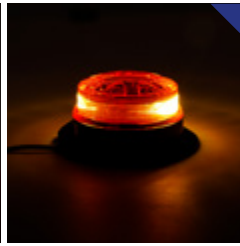
 5 904703 014409 >





-  Lampa Robocza LED
-  LED Work Lamp
-  LED-Arbeitsleuchte
-  LED munkalámpa

95 [mm]



10-30V
DC

95 x 97 x
34 mm

Red +
orange +
white

PC
ABS

27W

EAN code **6622**



5 904703 014447 >

95 [mm]



10-30V
DC

95 x 97 x
34 mm

Red +
orange +
white

PC
ABS

27W

EAN code **9030**



5 904703 017929 >



Ø128 [mm]



10-30V
DC

128 x
95 mm

Black +
orange

PC
Aluminum

30W

EAN code **6619**



5 904703 014454 >



Ø130 [mm]



10-30V
DC

130 x
65 mm

Black +
orange

PC
Aluminum



































































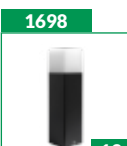



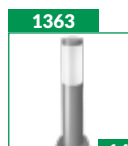

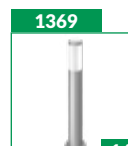









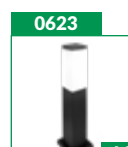
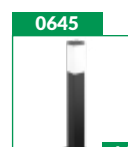







20W



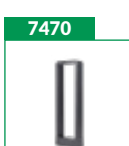
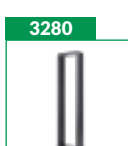
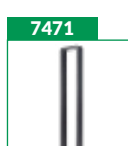
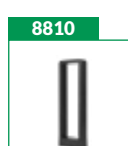
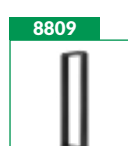
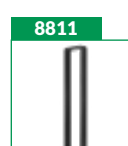

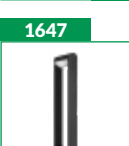
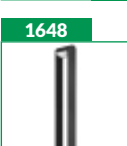

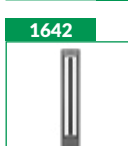
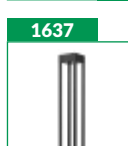





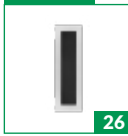



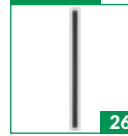

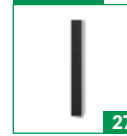
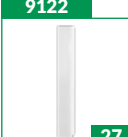
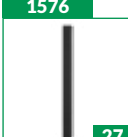
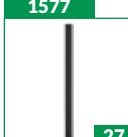













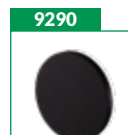

















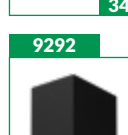
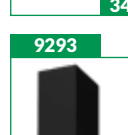
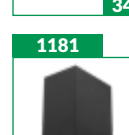

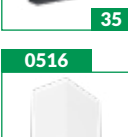
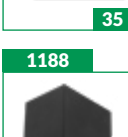
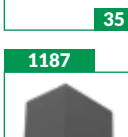





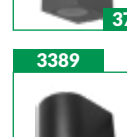

















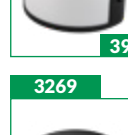









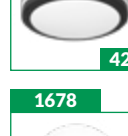
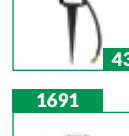
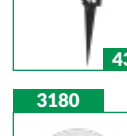
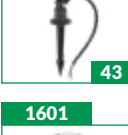
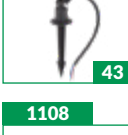
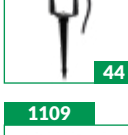



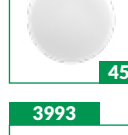

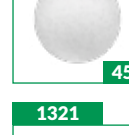
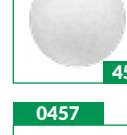
EAN code **6620**







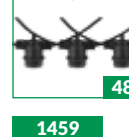





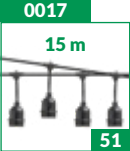































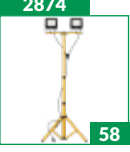

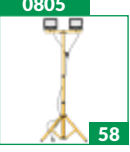





















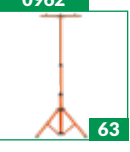

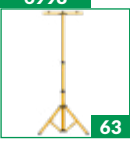























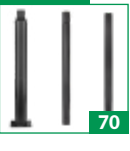
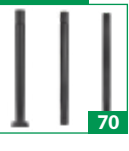

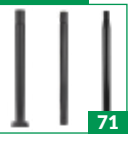
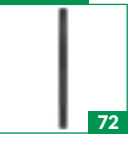









5 904703 014461 >



 6974 02	 9298 02	 9312 02	 3460 03	 3297 03	 3321 03	 3305 03	 3366 03	 3343 03	 9306 04
 9307 04	 9308 04	 9309 04	 9304 05	 9305 05	 9311 05	 9310 05	 5252 06	 5295 06	 5085 06
 5046 06	 5042 06	 5702 06	 1325 07	 1377 07	 1644 07	 1627 07	 2546 07	 8404 08	 8405 08
 8406 08	 1773 09	 1766 09	 8525 09	 1768 09	 4153 09	 6453 09	 1250 09	 1253 09	 1254 09
 1251 09	 0269 09	 1775 10	 1769 10	 1772 10	 8526 10	 7356 10	 0650 10	 0652 10	 2833 10
 0653 10	 3222 11	 3200 11	 3283 11	 1486 12	 2078 12	 1569 12	 7582 12	 7581 12	 3213 13
 3235 13	 1698 13	 9299 13	 1362 14	 6439 14	 0648 14	 1363 14	 0686 14	 1369 14	 0731 14
 6469 15	 3393 15	 4364 15	 4371 15	 5084 15	 3388 15	 7345 16	 7346 16	 0623 16	 0645 16
 0657 16	 0622 16	 4358 17	 4352 17	 4909 17	 4714 17	 3824 18	 3735 18	 7497 18	 7104 18
 7105 18	 7671 19	 7672 19	 7470 20	 3280 20	 7471 20	 8810 20	 8809 20	 8811 20	 1643 21
 1647 21	 1648 21	 1638 22	 1641 22	 1642 22	 1637 23	 9427 23	 0554 23	 0556 23	 9313 24

 9303 25	 9300 25	 0455 26	 0520 26	 0521 26	 8013 26	 0823 26	 0824 26	 1278 27	 1565 27
 9122 27	 1576 27	 1577 27	 8014 28	 8015 28	 1458 28	 7167 28	 6895 28	 9291 29	 4470 29
 3052 29	 3246 30	 2286 30	 2392 30	 7324 31	 3294 31	 3205 31	 9290 32	 9294 32	 1288 32
 1297 32	 9414 33	 9151 33	 2734 33	 9518 33	 9519 33	 9489 34	 9488 34	 9490 34	 9301 35
 9302 35	 9172 35	 9006 35	 9007 35	 0993 36	 0946 36	 9292 36	 9293 36	 1181 37	 1180 37
 0516 37	 1188 37	 1187 37	 0208 37	 0942 37	 0943 37	 3336 38	 3346 38	 0280 38	 3389 38
 3391 38	 2389 38	 5652 38	 5043 38	 7057 39	 0456 39	 6054 39	 3535 39	 8475 40	 7349 40
 7350 40	 4120 41	 4118 41	 6458 41	 2879 42	 0544 42	 3254 42	 3269 42	 0654 43	 7119 43
 2930 43	 5594 43	 FUTC04M 44	 MLTT03 44	 RL3-24 44	 RL1-24 44	 6689 45	 1678 45	 1691 45	 3180 45
 1601 45	 1108 46	 1109 46	 1260 46	 3253 47	 3220 47	 3993 47	 1466 47	 1321 48	 0457 48
 2817 48	 7814 48	 2544 48	 0018 49	 0019 49	 0020 49	 1322 50	 0451 50	 1459 50	 0016 51

LISTA PRODUKTÓV / LIST OF PRODUCTS / LISTE DER PRODUKTE / A TERMÉKEK LISTÁJA

 0017 15 m 51	 8637 51	 5251 52	 6695 52	 1508 53	 4992 53	 4991 53	 1375 53	 1387 53	 8072 54
 3742 54	 3745 54	 4837 55	 1646 55	 1865 55	 5128 55	 5105 55	 5104 55	 1456 56	 1447 56
 1463 56	 1792 56	 7818 56	 1795 56	 0939 56	 8683 56	 8681 56	 8682 56	 1464 57	 4430 57
 5795 57	 5796 57	 1446 57	 2874 58	 6982 58	 0805 58	 7815 58	 7816 59	 8692 59	 1625 59
 0311 59	 1659 60	 1660 60	 6563 60	 5125 60	 4142 60	 5124 60	 1221 61	 1481 61	 1482 61
 1663 62	 1733 62	 3533 62	 0356 62	 5293 62	 1900 63	 1731 63	 0962 63	 1257 63	 6777 63
 6998 63	 0611 64	 4998 64	 0007 64	 0127 64	 9018 65	 9019 65	 0525 65	 0526 65	 0604 65
 8073 65	 3322 66	 6529 66	 4141 66	 1488 66	 1473 66	 3765 67	 3259 67	 3185 67	 9282 68
 9283 68	 9284 68	 9317 69	 9315 69	 9316 69	 1886 70	 2634 70	 8602 71	 8603 71	 2775 72
 9233 72	 9234 72	 9235 72	 9236 72	 9241 72	 9243 72	 2671 73	 2304 73	 3362 73	 6681 73
 0664 73	 1619 73	 1628 73	 0478 74	 0479 74	 0477 74	 0475 74	 0472 75	 2245 75	 0471 75

LISTA PRODUKTÓW / LIST OF PRODUCTS / LISTE DER PRODUKTE / A TERMÉKEK LISTÁJA

 3424 75	 0474 76	 0473 76	 0480 76	 0481 76	 0482 76	 0483 76						
 9159 77	 9160 78	 9158 78	 9163 78	 9161 78	 9162 78	 2350 79	 2404 79	 2355 79	 2356 79			
 1191 80	 1198 80	 1354 80	 1438 80	 7145 81	 0277 81	 9271 82	 3656 82	 9252 83	 7115 83			
 1783 83	 9164 84	 4159 84	 0300 85	 0304 85	 3375 86	 9222 87	 9223 87	 2458 88	 4438 88			
 4920 88	 9620 89	 3651 89	 7307 90	 4363 90	 1361 90	 9619 91	 1593 91	 1296 92	 1762 92			
 4541 92	 0602 93	 6449 93	 0515 93	 0593 93	 7165 93	 0565 94	 9249 94	 1478 94	 8850 94			
 0624 94	 0299 95	 2125 95	 9835 95	 9244 95	 0557 96	 0567 96	 0743 96	 3173 96	 9245 97			
 9246 97	 9247 97	 3174 98	 3660 98	 8848 98	 3659 98	 9238 99	 9239 99	 9240 99	 3435 99			
 9242 99	 2007 100	 2943 100	 1313 100	 3658 100	 0315 101	 3744 101	 3276 101	 4849 101	 3653 102			
 1370 102	 3652 102	 3171 102	 3655 102	 3645 103	 1582 103	 7126 103	 7130 103	 2460 103	 9248 104			
 9272 104	 9273 104	 3780 1190 cm 105	 3670 2190 cm 105	 3669 3190 cm 105	 3665 4190 cm 105	 3668 5190 cm 105	 5004 105	 0637 20 x LED 106	 2288 40 x LED 106			

0736  10 x LED 106	3161  20 x LED 106	0138  20 x LED 106	2291  40 x LED 106	0305  107	3644  10 x LED 107	3657  20 x LED 107	1860  107	3662  108	3663  108		
2902  108	0745  108	2522  108									
3909  109	8840  109	2826  109	9472  109	3944  109	2825  109	8059  110	5047  110	7109  110	9471  110		
9469  110	9470  110	5191  111	1229  111	4935  111	6447  111	0463  112	0464  112	0467  112	8060  112		
2823  113	2157  113	2824  113	9473  114	9474  114	9475  114	9476  114	2828  115	6617  115	6618  115		
6621  115	6622  116	9030  116	6619  116	6620  116							







LVT SP. Z O.O.

**DZIAŁ EXPORTU / EXPORT DEPARTMENT /
EXPORTABTEILUNG / EXPORT OSZTÁLY:**

Katrzyna Złotowska
katarzyna@vipelectro.pl
katarzyna@lvt.com.pl
+48 58 355 01 40
+48 501 549 346



**DZIAŁ HANDLOWY – SPRZEDAŻ KRAJOWA / SALES DEPARTMENT /
VERKAUFSABTEILUNG / ÉRTÉKESÍTÉSI OSZTÁLY:**

Monika Wołowska
+48 58 355 01 35
handlowy@lvt.com.pl

**DYREKTOR DS. SIECI HANDLOWYCH /
SALES DIRECTOR FOR RETAIL NETWORKS /
VERKAUFSDIRECTOR FÜR EINZELHANDELSNETZE /
A KISKERESKEDELMI HÁLÓZATOK ÉRTÉKESÍTÉSI IGAZGATÓJA:**

Krzysztof Szrajter
+48 515 513 365
krzysztof.szrajter@vipelectro.pl

**NASZA SIEDZIBA / OUR HEADQUARTERS /
UNSER HAUPTSITZ / KÖZPONTUNK**



**DYREKTOR HANDLOWY / COMMERCIAL DIRECTOR /
KAUFMÄNNISCHER LEITER / KERESKEDELMI IGAZGATÓ:**

Sławomir Załużny
+48 789 404 142
slawomir@vipelectro.pl

**KOORDYNATOR HANDLOWCÓW REGIONALNYCH /
REGIONAL SALES COORDINATOR /
REGIONALER HÄNDLERKOORDINATOR /
REGIONÁLIS KERESKEDŐI KOORDINÁTOR:**

Regiony 1-6 / Regions 1-6 /
Regionen 1-6 / Régiók 1-6
Dominika Drężek
+48 58 355 01 36
dominika@lvt.com.pl

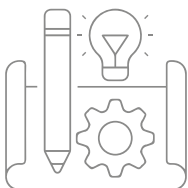

**DZIAŁ INWESTYCJI / INVESTMENT DEPARTMENT /
ABTEILUNG INVESTITIONEN / BEFEKTETÉSI OSZTÁLY:**

+48 571 447 388
inwestycje@lvt.com.pl

Skontaktuj się z nami (HURTOWNIA):
Contact us (SALES):
Kontaktieren Sie uns (GROSSHANDEL):
Lépjén kapcsolatba velünk (NAGYKERESKEDELEM):

Telefon / Phone number / Telefonnummer / Telefonszám:
+48 58 500 00 20
handlowy@lvt.com.pl

Odwiedź naszą stronę internetową:
Visit our website:
Besuche unsere Webseite:
Látogasd meg weboldalunkat:

<https://lvt.com.pl>

Lub zeskanuj kod QR:
Or scan the QR code:
Oder scannen Sie den QR-Code:
Vagy olvassa be a QR-kódot:



Lub odwiedź nas w siedzibie:
Or visit us at our HQ:
Oder besuchen Sie uns in unserem Hauptsitz:
Vagy látogasson el hozzánk főhadiszállásunkra:

LVT Sp. z o.o.
ul. Piecewska 19,
80-288 Gdańsk